

SEC-C Module Overview

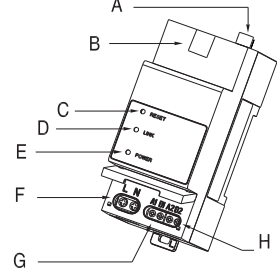

Fig 1: eSolar SEC-C definition

Code	Name
A	External Wi-Fi antenna
B	LAN
C	RESET
D	LINK** (LED INDICATOR)
E	POWER**2 (LED INDICATOR)
F	Power input
G	RS485 for inverter
H	RS485 for Smart meter

Table 1: Interface description

Note: *1 Green light slow blinking indicates Ethernet is connected to server, fast blinking indicates firmware is upgrading. Blue light slow blinking indicates WIFI is connected to server, fast blinking indicates Bluetooth is connected.

*2 LED indicator keeps ON indicating power is working properly, while LED indicator turning OFF indicates power supply is abnormal.

Monitoring APP Connection

1) Download eSAJ Home APP

For iOS system, search "eSAJ Home" in App Store to download.

For Android system, search "eSAJ Home" in Google Play to download.

2) Bluetooth connection

① Turn on mobile phone Bluetooth connection.

② Open eSAJ Home APP → Select "Tool" → "Remote Configuration" → Select "Bluetooth" → "Next STEP" → Search devices → Click on the Bluetooth name of the eSolar SEC-C.

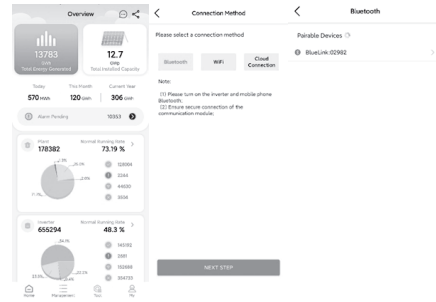
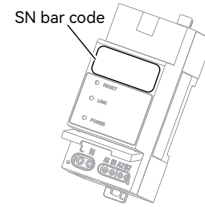

Fig 2 Bluetooth connection

Please use the eSAJ Home APP to scan the SN bar code on the front of the SEC-C module to link SEC-C module to inverter during power plant creation.



Parallel System Solution

Introduction:

Inverter parallel allows you to expand your power plant capacity and combine all the inverters to act as a single system to power the loads together. It is allowed to connect up to 10 inverters parallelly in the same system.

Total plant capacity:

The total power plant capacity can be reached up to 55.2KW.

RS485 cable splitter:

NOTE: The RS485 connection between inverters is daisy-chain connection.

The RS485 cable splitter enables you to increase the RS485 network connection on an RS485 port. The RS485 cables wiring is as figure 4 below, connect two RS485 cables from two different inverter to a single RS485 port.

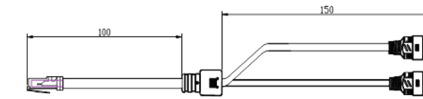

Fig 3: Ethernet cable splitter



Fig 4: Ethernet cable splitter and cable connection

RS485 Connection:

NOTE: In the networking state, the RS485 and 4G/WIFI interfaces of the inverter cannot be used at the same time.

1. Power on the inverters.

2. Set the inverter RS485 addresses to be different from each other. (Set the RS485 address to any number between 1 and 10, nonrepeat.), through the 4G/WIFI interface of the inverter connected to a WIFI-2 or AIO3 module or 4G module to modify.

- For R5/ R6/C6 series inverter: Set the address on the eSAJ Home APP.
- Install a communication module (WIFI-2 or AIO3 module or 4G module) onto the inverter, and connect to eSAJ Home APP.
- Procedure: Communication > RS485 setting > Address.
- After the RS485 address setting completed, disconnect the communication module.

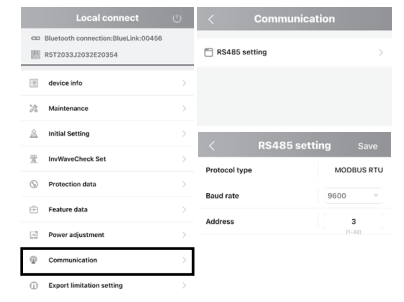

Fig 5: APP display for choosing RS485 address

1

2

3

3. Connect the RS485 cables, meter and SEC-C module (as the parallel system wiring diagram), then power on the SEC-C module.

4. After connecting to the eSAJ Home App, check if the displayed inverter and meter info are corrected.

Normal display: Then you should see all the devices list connected parallelly.

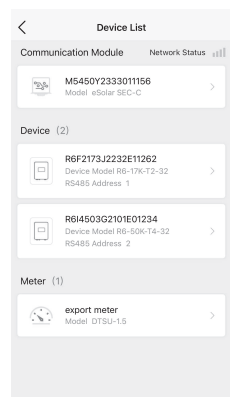

Fig 6: APP display for devices list

Parallel System Wiring:

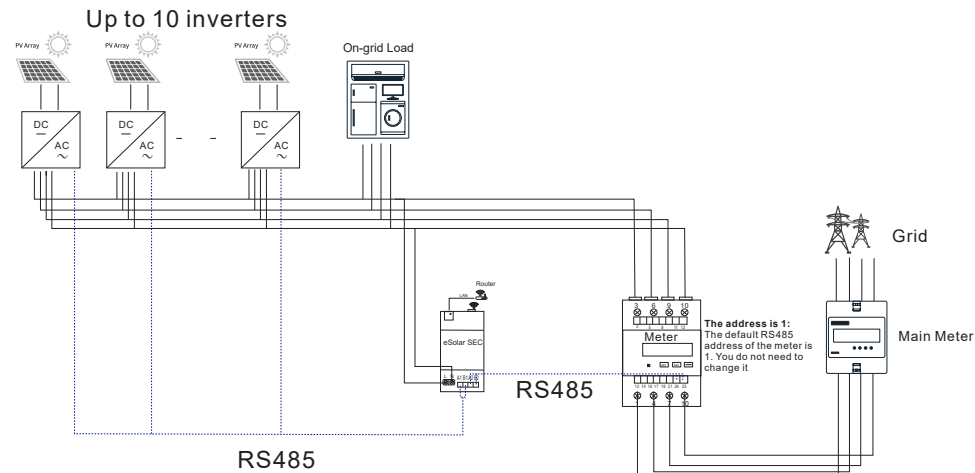

Fig 7: Parallel System Wiring

Export Limit Setting

Open eSAJ Home App, and connect all the devices to App.

1. Enter eSolar SEC-C interface.

2. Select the gear icon at the top-right corner.

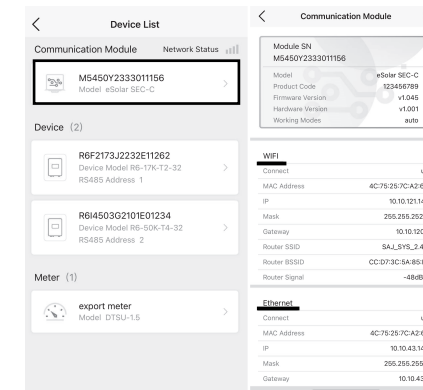

Fig 8: eSolar SEC-C interface Connection

3. Select Export limitation setting.

4. Enter the export limit value.

5. Click on "Save".

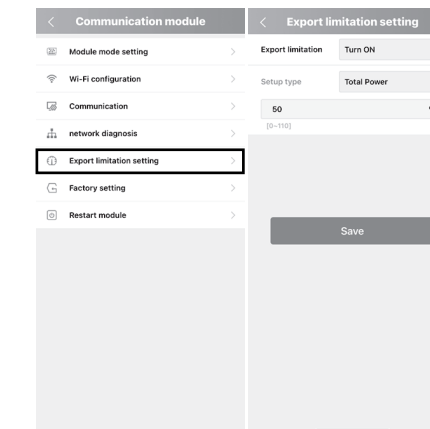

Fig 9: A Export limitation setting

4

5

6