

eSolar 4G Pro

Quick Start Guide

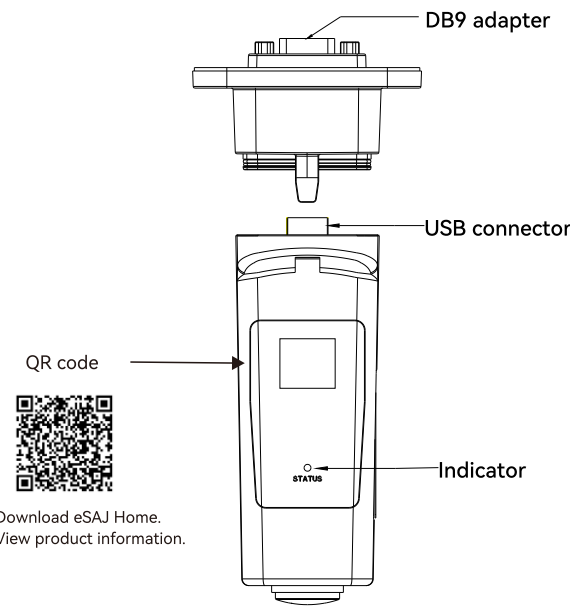

LED Indicator Status		
Green	Slow blinking	Module is working
	Fast blinking	Firmware is upgrading
	Solid	Module is not connected to server
	Off	No power supply or program fault
Blue	Slow blinking	/
	Fast blinking	Bluetooth is connected

Slow blink (1s on, 1s off); Fast blink (200ms on, 200ms off)

1. Usage and Connection

1.1 SIM Card Installation

Insert the SIM card into the 4G Pro communication module as shown below:

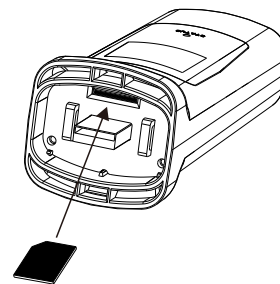

1.2 When the inverter communication port is a USB port:

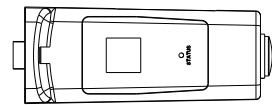

Installation

Open the cover of the inverter communication port. Insert the 4G Pro communication module into the communication port.

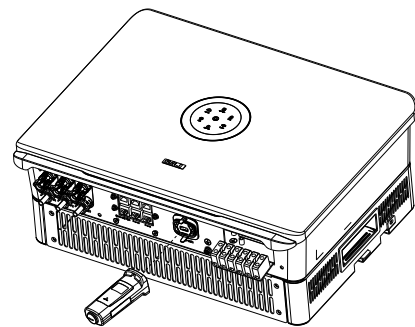

Disassembly

Unplug the 4G Pro communication module from the inverter.

1.3 When the inverter communication port is a DB9 port:

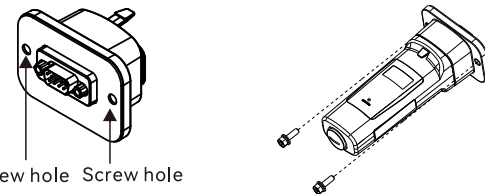

Installation

Insert the 4G Pro module into the inverter communication port (RS-232/WIFI port), and use two screws to secure the 4G Pro communication module on the inverter.

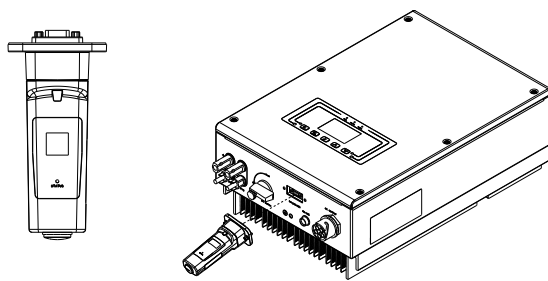

Disassembly

Use a screwdriver to remove two screws and unplug the 4G Pro communication module from the inverter.

2. Commissioning

2.1 App Downloading and Account Registering

- On your mobile phone, search for "eSAJ Home" in the App store and download the App.
- Scan the QR code on the 4G Pro communication module to download the App and view product information.
- If you do not have an account, tap **Register** to apply for one account.

2.2 Bluetooth Connection

- Open the App and tap the three-dot icon on the top right the top right corner.
- Set the **Language** to **English**, and choose the **Network Node** according to your current location.
- Enter the account and password to log in to the App.

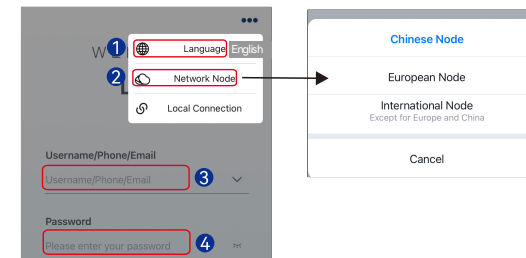

- Enable the Bluetooth function on your mobile phone.
- Go to the **Service** interface and select **Remote Configuration**. Click **Bluetooth**. Then, click **Next**.
- Choose the corresponding BlueLink name of the 4G Pro module.

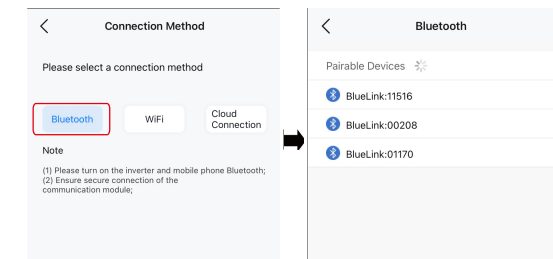

2.3 APN Setting

Note: Users selected Chinese Node do no need to fill in the APN information. After choosing the correct BlueLink, click the eSolar 4G Pro module and tap **APN Settings**. Then, fill in the APN of your SIM card.

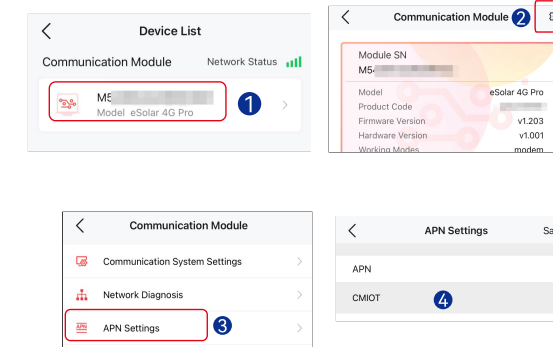

2.4 Inverter Settings

Country and **Grid Compliance** can be viewed from the **initialization** settings. After commissioning, **Basic Info**, **Running Info**, **Power Generation**, and **Event Info** included in the **Device Info** can be viewed.

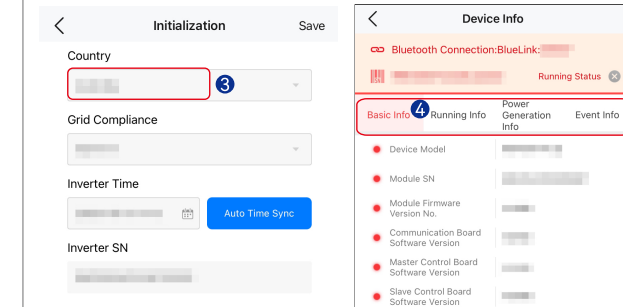
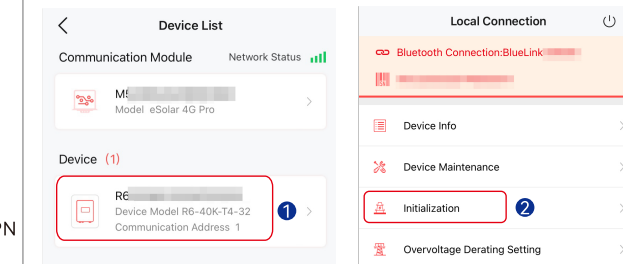

eSolar 4G Pro

快速安装指南

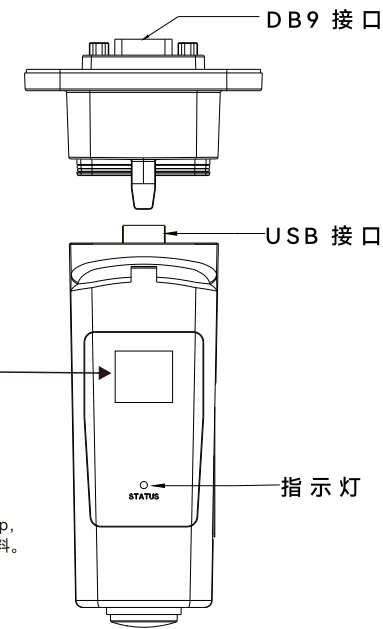

扫二维码可下载App, 并获取更多产品资料。

1. 安装与连接

1.1 SIM卡安装

如下图, 将SIM卡按照相应方向装入4G Pro通讯模块中。

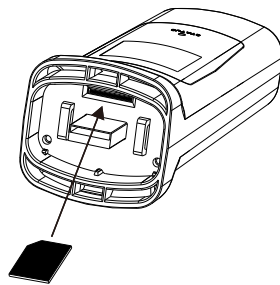

LED 指示灯状态说明		
绿色	慢闪	模块正常工作
	快闪	固件升级中
	长亮	模块正常启动, 未连接服务器
蓝色	灭	模块供电异常或程序启动异常
	慢闪	/
	快闪	蓝牙通讯中

慢闪 (1s亮, 1s灭); 快闪 (200ms亮, 200ms灭)

1.2 当逆变器的通讯接口为USB接口时:

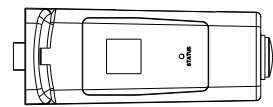

安装方式

先打开逆变器通讯接口的防尘盖, 再把4G Pro模块直接接入到逆变器的通讯接口。当锁扣发出“咔”的一声, 则安装完成。

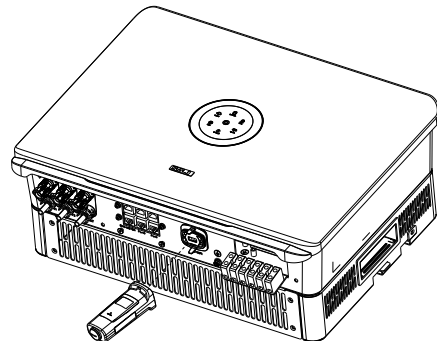

拆解方式

按压锁扣, 直至4G Pro模块可抽出。抽出后, 则拆解完成。

1.3 当逆变器的通讯接口为DB9接口时:

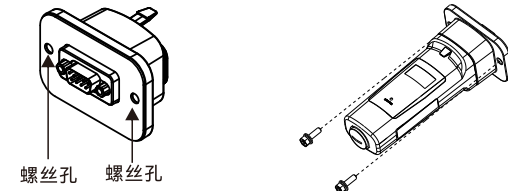

安装方式

先将4G Pro模块接入逆变器的 (RS-232/WIFI 接口) 通讯接口中, 再用两颗螺丝将模块锁紧在逆变器上。

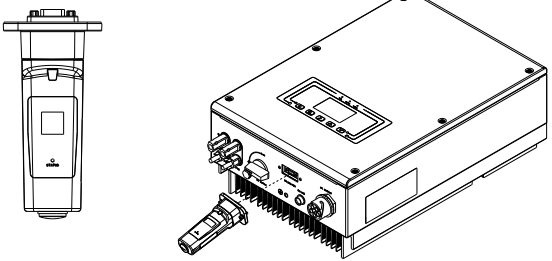

拆解方式

先用螺丝刀将4G Pro模块两侧的螺丝取下, 再把模块从逆变器的通讯接口上抽出。

2. 安装商配置

2.1 App 下载与账号注册

(1) App下载方式: ① 直接扫描4G Pro通讯模块上的二维码; ② 若手机系统为iOS系统, 可打开手机的App Store并搜索“晶太阳家庭”; ③ 若手机系统为Android系统, 可打开手机的应用商城搜索“晶太阳家庭”。
(2) 当App下载完成时, 打开App。如果没有账号, 请先注册账号。

2.2 蓝牙连接

① 打开App, 点击App界面右上角的三点标志 ;
② 设置语言为中文, 并设置网络节点为中国节点;
③ 输入账号密码并登入App。



④ 打开手机设置中的蓝牙功能;
⑤ 点击App主界面最下方的服务界面, 并选择最上方的远程配置。再点击蓝牙连接, 并点击下一步;
⑥ 选择模块相应的蓝牙名称。



2.3 APN 设置

注: 选择“中国节点”的用户无需填写APN信息。
(1) 选择上方的eSolar 4G Pro模块, 并点击右方的设置按键;
(2) 点击APN设置, 并填写SIM卡对应的APN。



2.4 逆变器设置

(1) 选择逆变器设备并进入初始化设置, 可以设置或查看设备的国家和电网标准码。
(2) 配置完成后, 进入设备信息, 可以查看设备的基本信息、运行信息、发电信息、以及事件信息。

