



**GUANGZHOU SANJING ELECTRIC CO.,LTD**

Tel: (86)20 66608588 Fax: (86)20 66608589 Web: [www.saj-electric.com](http://www.saj-electric.com)

Add: SAJ Innovation Park, No.9, Lizhishan Road, Science City, Guangzhou High-tech Zone, Guangdong, P.R.China.

V0.1

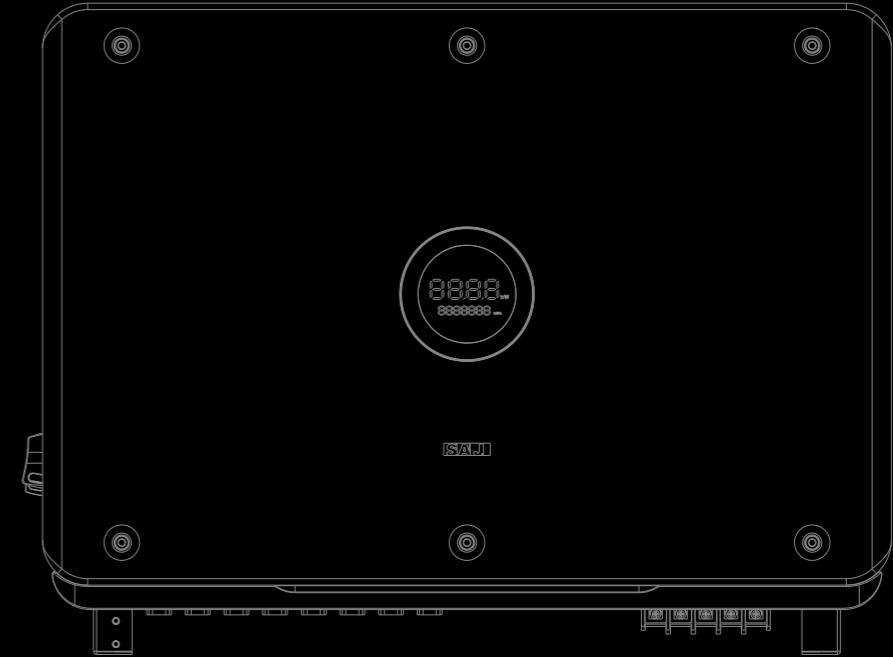

# R6 series

**ROOFTOP SOLAR INVERTER**

user manual

R6-(8K-50K)-(T2,T4)-32-AUS

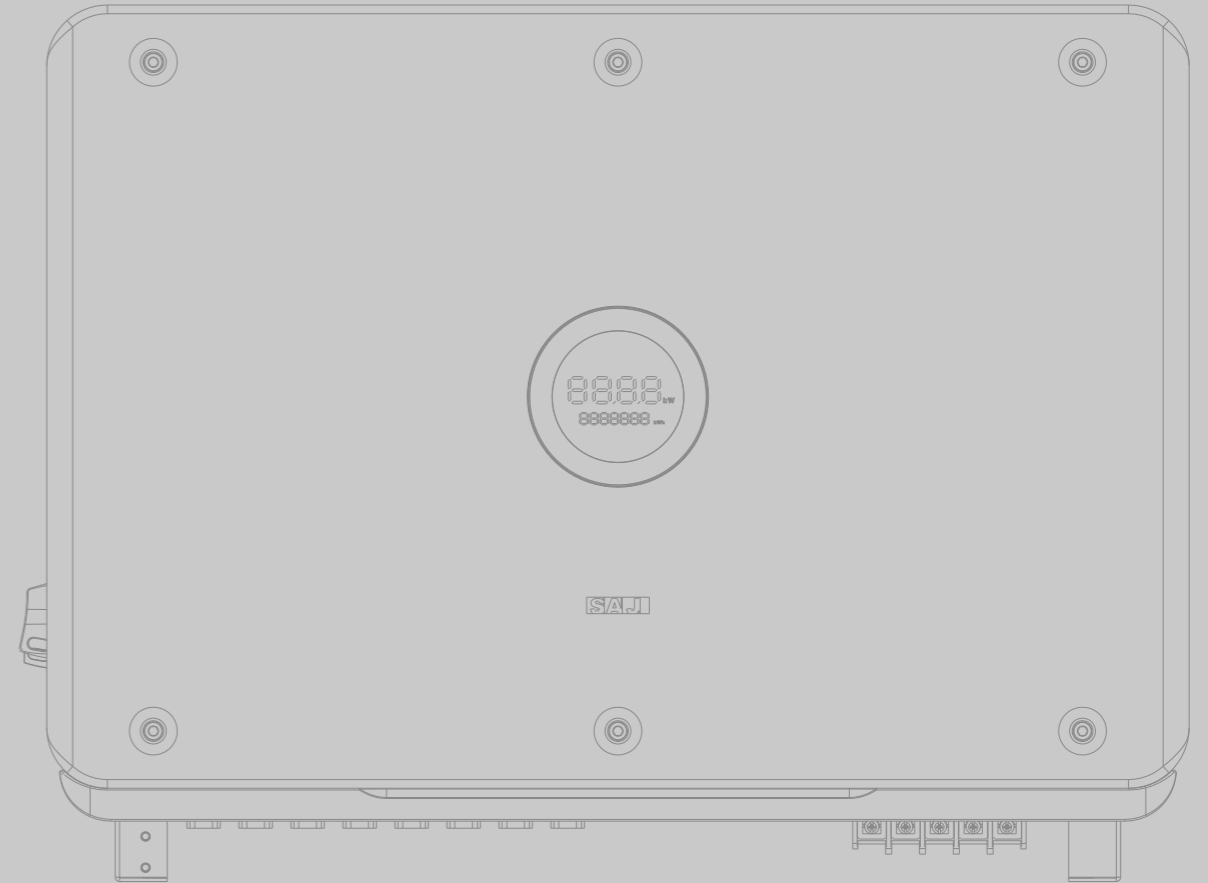

# TABLE OF contents



## 1. SAFETY PRECAUTIONS -----01

- 1.1 Scope of Application-----02
- 1.2 Safety -----02
  - 1.2.1 Safety Instruction-----02
  - 1.2.2 Explanations of Symbols-----03
  - 1.2.3 Safety Instructions-----04



## 2. PRODUCT OVERVIEW -----05

- 2.1 Specification for Product Model----- 07
- 2.2 Appearance-----07
- 2.3 Safe Handling----- 08
- 2.4 Datasheet----- 09



## 3. INSTALLATION INSTRUCTION----- 13

- 3.1 Safety Instructions----- 14
- 3.2 Pre-installation Check----- 14
- 3.3 Determination the  
Installation method and Position-----15
- 3.4 Mounting Procedure-----17



## 4. ELECTRICAL CONNECTION-----21

- 4.1 Safety Instruction -----22
- 4.2 Earth Fault Alarm-----22
- 4.3 Specifications for Electrical Interface--23
- 4.4 AC Connection----- 24



## 5. DEBUGGING INSTRUCTIONS----- 33

- 4.5 DC Side Connection----- 27
- 4.6 Communication Connection-----29
- 4.7 Multiple Inverter Combinations-----31
- 4.8 Start up and Shut down Inverter-----32
- 4.9 AFCI-----32
- 5.1 Introduction of HMI----- 34
- 5.2 Monitoring Operation----- 35
  - 5.2.1 Downloading the eSAJ Home App----- 35
  - 5.2.2 Logging in to the App----- 36
  - 5.2.3 Completing the Initialization Settings--- 37
  - 5.2.4 Protection Parameter Setting----- 38
  - 5.2.5 Inverter Setting Review----- 39
  - 5.2.6 Remote Monitoring----- 39
- 5.3 Setting Reactive Power Control----- 40
- 5.4 Export Limit Setting----- 44
- 5.5 Self-test----- 46



## 6. FAULT CODE & Troubleshooting----- 49



## 7. TRANSPORTATION & DISPOSAL----- 53

- 7.1 Transportation----- 54
- 7.2 Recycling and Disposal----- 54

## 8. ROUTINE MAINTENANCE----- 55

## 1.

SAFETY  
precautions

## 1.1 Scope of Application

This User Manual describes instructions and detailed procedures for installing, operating, maintaining, and troubleshooting of the following SAJ on-grid inverters:

R6-8K-T2-32-AUS, R6-10K-T2-32-AUS, R6-15K-T2-32\_AUS, R6-20K-T2-32-AUS,  
R6-25K-T2-32-AUS, R6-25K-T4-32-AUS, R6-30K-T4-32-AUS, R6-33K-T4-32-AUS  
R6-40K-T4-32-AUS, R6-50K-T4-32-AUS

Please keep this manual all time available in case of emergency.

## 1.2 Safety

### 1.2.1 Safety Instructions

**DANGER**

· DANGER indicates a hazardous situation, which, if not avoided, will result in death or serious injury.

**WARNING**

· WARNING indicates a hazardous situation, which, if not avoided, can result in death or serious injury or moderate injury.









**CAUTION**

· CAUTION indicates a hazardous condition, which, if not avoided, can result in minor or moderate injury.

**NOTICE**

· NOTICE indicates a situation that can result in potential damage, if not avoided.

## 1.2.2 Explanations of Symbols

Symbol	Description
	<b>Dangerous electrical voltage</b> This device is directly connected to public grid, thus all work to the inverter shall only be carried out by qualified personnel.
	<b>Danger to life due to high electrical voltage!</b> There might be residual currents in inverter because of large capacitors. Wait 5 minutes before you remove the front lid.
	<b>Notice, danger!</b> This is directly connected with electricity generators and public grid.
	<b>Danger of hot surface</b> The components inside the inverter will release a lot of heat during operation. Do not touch metal plate housing during operating.
	<b>An error has occurred</b> Please go to Chapter 6 "Troubleshooting" to remedy the error.
	<b>This device SHALL NOT be disposed of in residential waste</b> Please go to Chapter 7 "Recycling and Disposal" for proper treatments.
	<b>CE Mark</b> With CE mark & the inverter fulfills the basic requirements of the Guideline Governing Low-Voltage and Electro-magnetic Compatibility.
	<b>CQC Mark</b> The inverter complies with the safety instructions from China's Quality Center.

## 1.2.3 Safety Instructions

 **DANGER**

- There is possibility of dying due to electrical shock and high voltage.
- Do not touch the operating component of the inverter; it might result in burning or death.
- To prevent risk of electric shock during installation and maintenance, please make sure that all AC and DC terminals are plugged out.
- Do not touch the surface of the inverter while the housing is wet, otherwise, it might cause electrical shock.
- Do not stay close to the inverter while there are severe weather conditions including storm, lightning, etc.
- Before opening the housing, the SAJ inverter must be disconnected from the grid and PV generator; you must wait for at least five minutes to let the energy storage capacitors completely discharged after disconnecting from power source.

 **WARNING**

- The installation, service, recycling and disposal of the inverters must be performed by qualified personnel only in compliance with national and local standards and regulations.
- Any unauthorized actions including modification of product functionality of any form may cause lethal hazard to the operator, third parties, the units or their property. SAJ is not responsible for the loss and these warranty claims.
- The SAJ inverter must only be operated with PV generator. Do not connect any other source of energy to the SAJ inverter.
- Be sure that the PV generator and inverter are well grounded in order to protect properties and persons.

 **CAUTION**

- The solar inverter will become hot during operation. Please do not touch the heat sink or peripheral surface during or shortly after operation.
- Risk of damage due to improper modifications.

 **NOTICE**

- Public utility only.
- The solar inverter is designed to feed AC power directly to the public utility power grid; do not connect AC output of the inverter to any private AC equipment.

## 2.

PRODUCT  
overview

## R6 series

R6 Series products are grid-tied three phase inverters without transformers, and the inverters are important components of grid-tied solar power systems.

The R6 inverter converts the DC generated by solar panels into AC which is in accordance with the requirements of public grid and send the AC into the grid, Figure 2.1 shows the structural diagram of the typical application system.

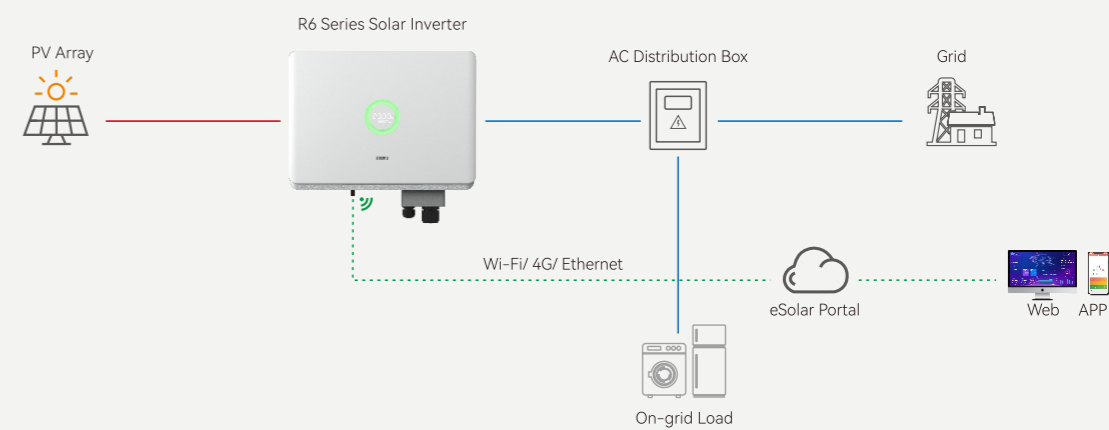

Figure 2.1  
System overview

## 2.1 Specification for Product Model

**R6 - XK - TX - 32-AUS**

①      ②      ③      ④      ⑤

- ① R6 represents for product name.
- ② XK represents rated power XkW of inverter, for example 4K means 4kW.
- ③ T means three phase; X represents the inverter has the function of X MPP trackers.
- ④ 32 means that max. DC input current of per MPP tracker is 32A
- ⑤ AUS indicates this model is ONLY applicable to Australia

## 2.2 Appearance

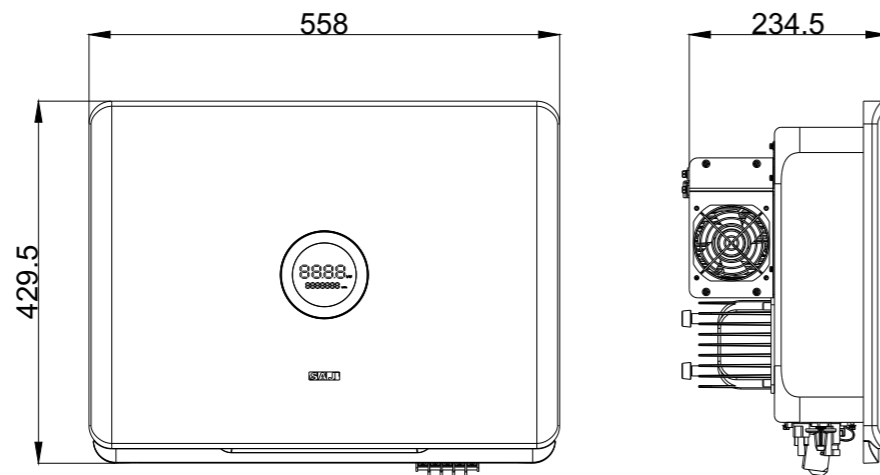

Figure 2.2  
Dimensions of  
R6-8K/10K/15K/20K/25K-T2-32-AUS

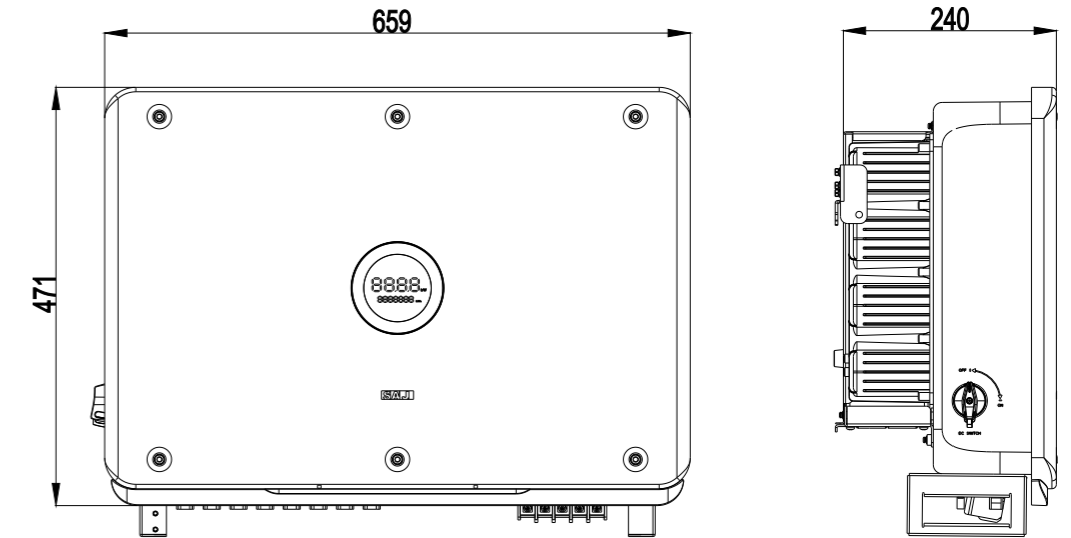

Figure 2.3  
Dimensions of  
R6-25K/30K/33K/40K/50K-T4-32-AUS

## 2.3 Safe Handling

The R6-(8K-50K) series inverters have been designed and tested strictly according to international safety regulations. Ad, and maintained in strict accordance with related safety instructions. Incorrect operation or ms an electrical and electronic equipment, the inverter must be installed, commissioned, operateisuse of this device may cause personal injury or device damage. This will void the limit warranty and SAJ will not be responsible for the loss caused by those behaviors.

- The inverter must be installed and maintained by authorized technicians based on local laws and regulations.
- Before installing or maintaining the inverter, make sure that it is disconnected from the grid.
- When the inverter is working, do not plug in or out the cables.
- For the disposal or recycling, refer to section 7.2 "Recycling and Disposal".

## 2.4 Datasheet

### R6-8K/10K/15K/20K/25K-T2-32-AUS

Model	R6-8K-T2-32-AUS	R6-10K-T2-32-AUS	R6-15K-T2-32-AUS	R6-20K-T2-32-AUS	R6-25K-T2-32-AUS
<b>Input (DC)</b>					
Max. PV Array Power [Wp]@STC	12000	15000	22500	30000	37500
Max. Input Voltage [V]	1100				
MPPT Voltage Range [V]	180-1000				
Nominal Input Voltage [V]	600				
Start-up Voltage [V]	200				
Max. Input Current [A]	32/32				
Max. Short-Circuit Current[A]	38.4/38.4				
Number of MPP Trackers	2				
Number of Strings per MPP Tracker	2/2				
Overvoltage Category (OVC)	II				
<b>Output (AC)</b>					
Rated AC Power [W]	8000	9999	15000	20000	25000
Rated Apparent Power [VA]	8000	9999	15000	20000	25000
Max. Apparent Power [VA]	8000	9999	15000	20000	25000
Rated AC Output Current [A]	11.6	14.5	21.8	29.0	36.3
Max. AC Output Current [A]	11.6	14.5	21.8	29.0	36.3
Current Inrush [A]	35.0		42.0		
Max. AC Fault Current [A]	91.0		100.0		
Max. AC Over Current Protection [A]	68.0		80.0		
Nominal AC Voltage/ Range [V]	3+N+PE, 220/380, 230/400, 240/415; 180-280/312-485				
Nominal AC Grid Frequency/ Range [Hz]	50, 60/44-55, 55-65				
Total Distortion Harmonic [THDi]	< 3%				
Power Factor	0.8 leading ~ 0.8 lagging				
Overvoltage Category (OVC)	III				
<b>Efficiency</b>					
Max. Efficiency	98.8%				
Euro Efficiency	98.5%				
<b>Protection</b>					
Internal Overvoltage Protection	Integrated				
DC Insulation Resistance Detection	Integrated				
Grid Monitoring	Integrated				
GFCI Monitoring	Integrated				
DCI Monitoring	Integrated				
AC Short Circuit Current Protection	Integrated				

Mode	R6-8K-T2-32-AUS	R6-10K-T2-32-AUS	R6-15K-T2-32-AUS	R6-20K-T2-32-AUS	R6-25K-T2-32-AUS
AC Grounding Detection	Integrated				
DC Surge Protection	Integrated				
AC Surge Protection	Integrated				
Anti-islanding Protection	Integrated				
AFCI Protection	Integrated				
<b>Interface</b>					
AC Connection	Terminal Block				
DC Connection	D4;MC4(optional)				
Display	LED+APP				
Communication Port	RS232(USB)+RS485(RJ45)+DRM				
Communication Mode	Bluetooth; Wi-Fi; Ethernet; 4G (optional)				
<b>General Data</b>					
Topology	Non-isolated				
Nighttime Power Consumption [W]	<1				
Operating Temperature Range	-40°C to +60°C (45°C to 60°C with derating)				
Cooling Method	Intelligent fan Cooling				
Ambient Humidity	0% ~ 100% non-condensing				
Max. Operating Altitude [m]	4000m (>3000m power derating)				
Noise [dBA]	<50				
Protective Class	Class I				
Ingress Protection	IP65				
Mounting	Wall Mounting				
Dimensions [H*W*D] [mm]	429.5*558*234.5				
Weight [kg]	22.5				
Warranty [Year]	Refer to the warranty policy				
Certifications	EN 62109-1/2, EN 61000-6-1/2/3/4, EN 50438, EN 50549, C10/11, IEC 62116, IEC 61727, RD 1699, RD 413, UNE 206006, UNE 206007, NTS, CEI 0-16, CEI O-021, AS/NZS 4777.2, NBR 16149, NBR 16150 VDE-AR-N 4105, VDE 0126-1-1				



## R6-25/30K/33K/40K/50K-T4-32-AUS

Model	R6-25K-T4-32-AUS	R6-30K-T4-32-AUS	R6-33K-T4-32-AUS	R6-40K-T4-32-AUS	R6-50K-T4-32-AUS
<b>Input (DC)</b>					
Max. PV Array Power [Wp]@STC	37500	45000	49500	60000	75000
Max. Input Voltage [V]	1100				
MPPT Voltage Range [V]	180-1000				
Nominal Input Voltage [V]	600				
Start-up Voltage [V]	200				
Max. Input Current [A]	32/32/32/32				
Max. Short-Circuit Current[A]	38.4/38.4/38.4/38.4				
Number of MPP Trackers	4				
Number of Strings per MPP Tracker	2/2/2/2				
Overvoltage Category (OVC)	II				
<b>Output (AC)</b>					
Rated AC Power [W]	25000	29999	33000	40000	50000
Rated Apparent Power [VA]	25000	29999	33000	40000	50000
Max. Apparent Power [VA]	25000	29999	33000	40000	50000
Rated AC Output Current [A]	36.3	43.5	47.9	58	72.5
Max. AC Output Current [A]	36.3	43.5	47.9	58	72.5
Current Inrush [A]	55.0		60.0		
Max. AC Fault Current [A]	150.0		165.0		
Max. AC Over Current Protection [A]	112.0		120.0		
Nominal AC Voltage/ Range [V]	3+N+PE, 220/380, 230/400, 240/415; 180-280/312-485				
Nominal AC Grid Frequency/ Range [Hz]	50, 60/44-55, 55-65				
Total Distortion Harmonic [THDi]	< 3%				
Power Factor	0.8 leading ~ 0.8 lagging				
Overvoltage Category (OVC)	III				
<b>Efficiency</b>					
Max. Efficiency	98.8%				
Euro Efficiency	98.5%				
<b>Protection</b>					
Internal Overvoltage Protection	Integrated				
DC Insulation Resistance Detection	Integrated				
Grid Monitoring	Integrated				
GFCI Monitoring	Integrated				
DCI Monitoring	Integrated				
AC Short Circuit Current Protection	Integrated				

Mode	R6-25K-T4-32-AUS	R6-30K-T4-32-AUS	R6-33K-T4-32-AUS	R6-40K-T4-32-AUS	R6-50K-T4-32-AUS
AC Grounding Detection	Integrated				
DC Surge Protection	Integrated				
AC Surge Protection	Integrated				
Anti-islanding Protection	Integrated				
AFCI Protection	Integrated				
<b>Interface</b>					
AC Connection	Terminal Block				
DC Connection	D4; MC4(optional)				
Display	LED+APP				
Communication Port	RS232(USB)+RS485(RJ45)+DRM				
Communication Mode	Bluetooth; Wi-Fi; Ethernet; 4G (optional)				
<b>General Data</b>					
Topology	Non-isolated				
Nighttime Power Consumption [W]	<1				
Operating Temperature Range	-40°C to +60°C (45°C to 60°C with derating)				
Cooling Method	Intelligent fan Cooling				
Ambient Humidity	0% ~ 100% non-condensing				
Max. Operating Altitude [m]	4000m (>3000m power derating)				
Noise [dBA]	<50				
Protective Class	Class I				
Ingress Protection	IP65				
Mounting	Wall Mounting				
Dimensions [H*W*D] [mm]	473*659.4*240				
Weight [kg]	36.5				37
Warranty [Year]	Refer to the warranty policy				
Certifications	EN 62109-1/2, EN 61000-6-1/2/3/4, EN 50438, EN 50549, C10/11, IEC 62116, IEC 61727, RD 1699, RD 413, UNE 206006, UNE 206007, NTS, CEI 0-16, CEI O-021, AS/NZS 4777.2, NBR 16149, NBR 16150 VDE-AR-N 4105, VDE 0126-1-1				

# 3.

# INSTALLATION

## instruction



## 3.1 Safety Instructions

### DANGER

- Dangerous to life due to potential fire or electricity shock.
- Do not install the inverter near any inflammable or explosive items.
- This inverter will be directly connected with HIGH VOLTAGE power generation device; the installation must be performed by qualified personnel only in compliance with national and local standards and regulations.

### NOTICE

- This equipment meets the pollution degree II.
- Inappropriate or the harmonized installation environment may jeopardize the life span of the inverter.
- Installation directly exposed under intensive sunlight is not recommended.
- The installation site must be well ventilated.

## 3.2 Pre-installation Check

### 3.2.1 Check the Package

Although SAJ's inverters have thoroughly tested and checked before delivery, it is uncertain that the inverters may suffer damages during transportation. Please check the package for any obvious signs of damage, and if such evidence is present, do not open the package and contact your dealer as soon as possible.

### 3.2.2 Scope of Delivery

Please contact after sales if there is missing or damaged components.

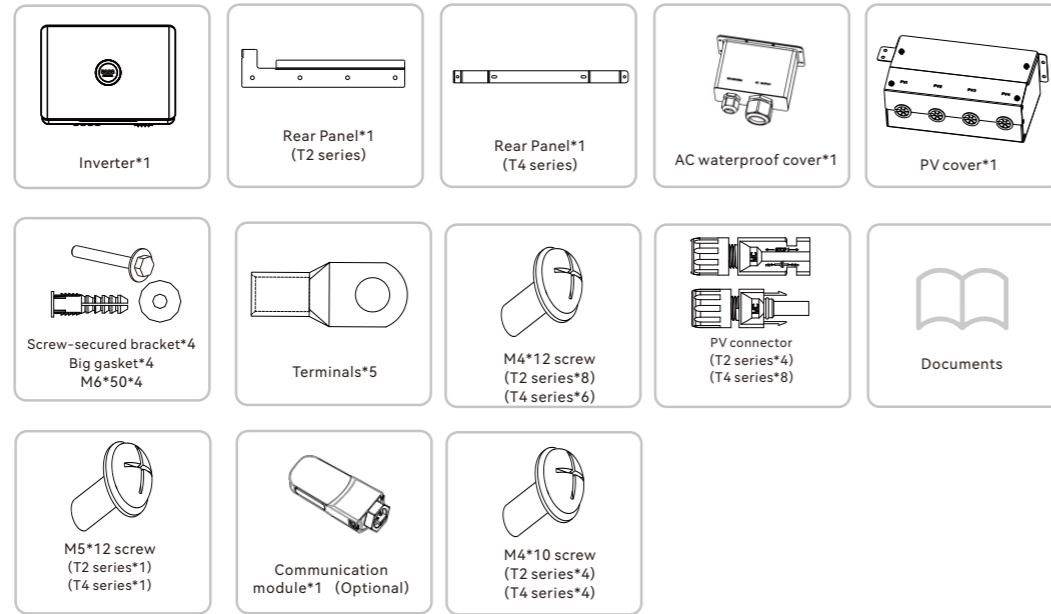

The documents include the user manual, quick installation guide and packaging list.

The equipment employs intelligent fan Cooling, and it can be installed indoor or outdoor.  
 (1) Do not expose the inverter to direct solar irradiation as this could cause power derating due to overheating.

(2) Mount vertically or tilted backwards by max. 15°. Never install the inverter tilted forwards, sideways, horizontally or upside down.

(3) Install the inverter at eye level for convenience when checking the LCD display and possible maintenance activities.

(4) When mounting the inverter, please consider the solidness of wall for inverter, including accessories. Please ensure the Rear Panel mount tightly.

To make sure the installation spot is suitably ventilated, if multiple SAJ on-grid solar inverters are installed same area.

### 3.3 Determine the installation method and position

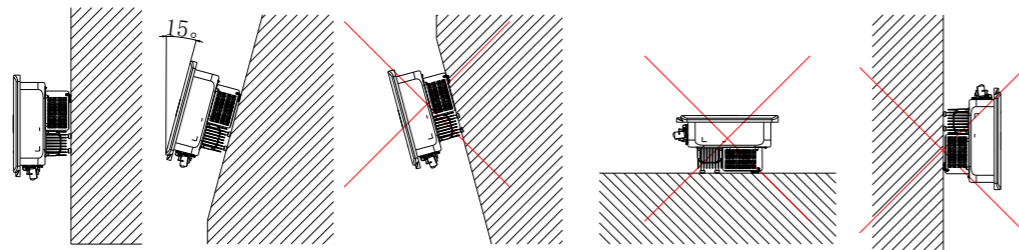

Figure 3.1  
Mounting Method

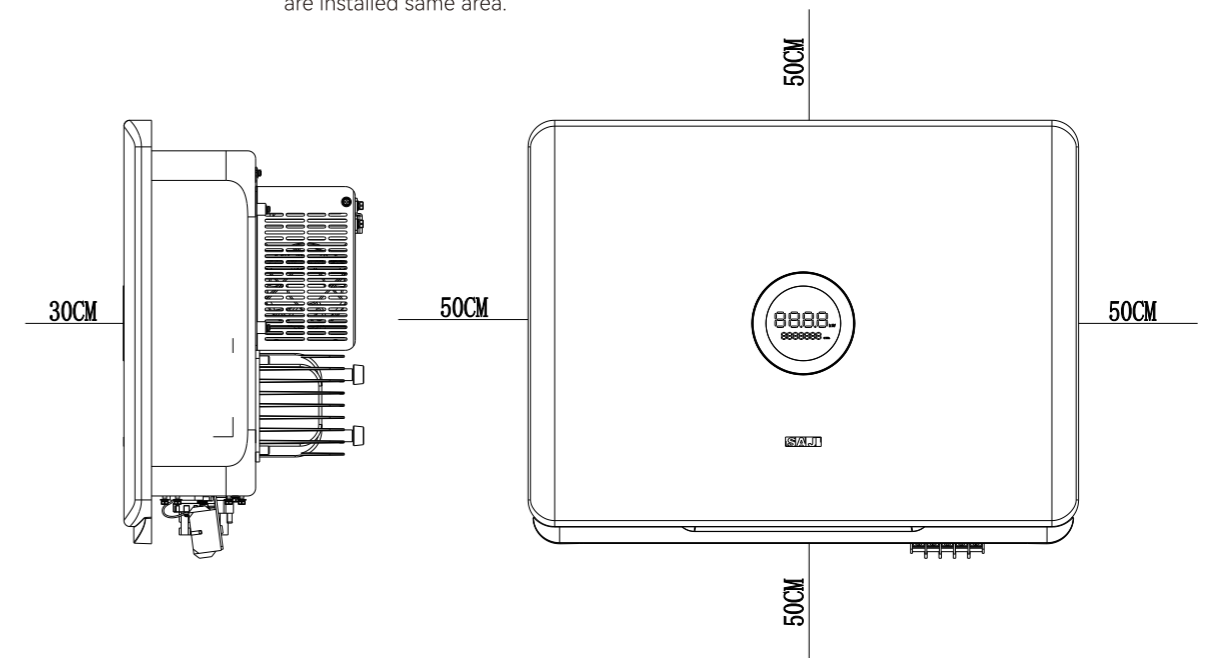

Figure 3.2  
Minimum Clearance

### Installation Environment Requirements

- The installation environment must be free of inflammable or explosive materials.
- Install the device away from heat source.
- Do not install the device at a place where the temperature changes extremely.
- Keep the device away from children.
- Do not install the device at daily working or living areas, including but not limited to the following areas: bedroom, lounge, living room, study, toilet, bathroom, theater and attic.
- When installing the device at the garage, please keep it away from drive way.
- Keep the device from water sources such as taps, sewer pipes and sprinklers to prevent water seepage.
- The product is to be installed in a high traffic area where the fault is likely to be seen.

Note: When installing outdoors, the height of the device from the ground should be considered to prevent the device from soaking in water. The specific height is determined by the site environment.

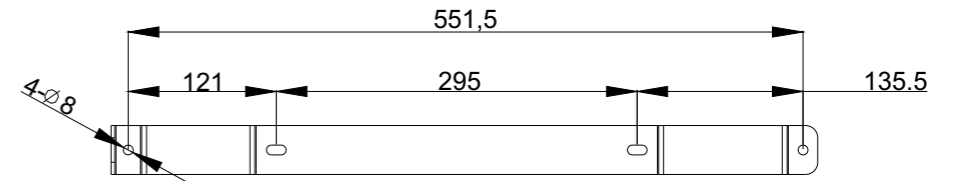

Figure 3.4  
Dimensions of rear panel of  
R6-25K/30K/33K/40K/50K-T4-32-AUS

## 3.4 Mounting Procedure

### (1) Mark the Positions of the Drill Holes of the Rear Panel

The mounting position should be marked as shown in Figure 3.3& Figure 3.4.

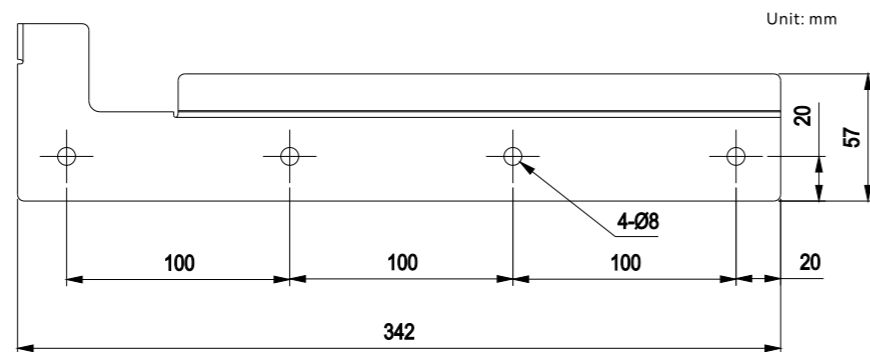

Figure 3.3  
Dimensions of rear panel of  
R6-8K/10K/15K/20K/25K-T2-32-AUS

### (2) Drill Holes and Place the Expansion Tubes

Drill 4 holes in the wall (in conformity with position marked in Figure 3.5 & Figure 3.6), and then place expansion tubes in the holes using a rubber mallet.

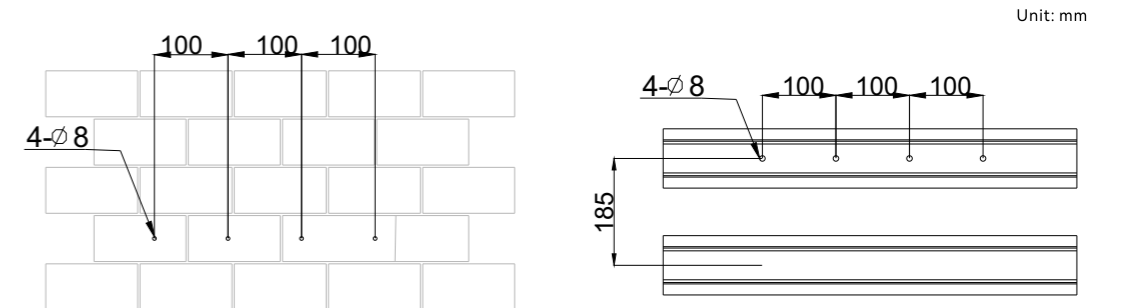

Figure 3.5  
Drill holes' dimensions of  
R6-8K/10K/15K/20K/25K-T2-32-AUS

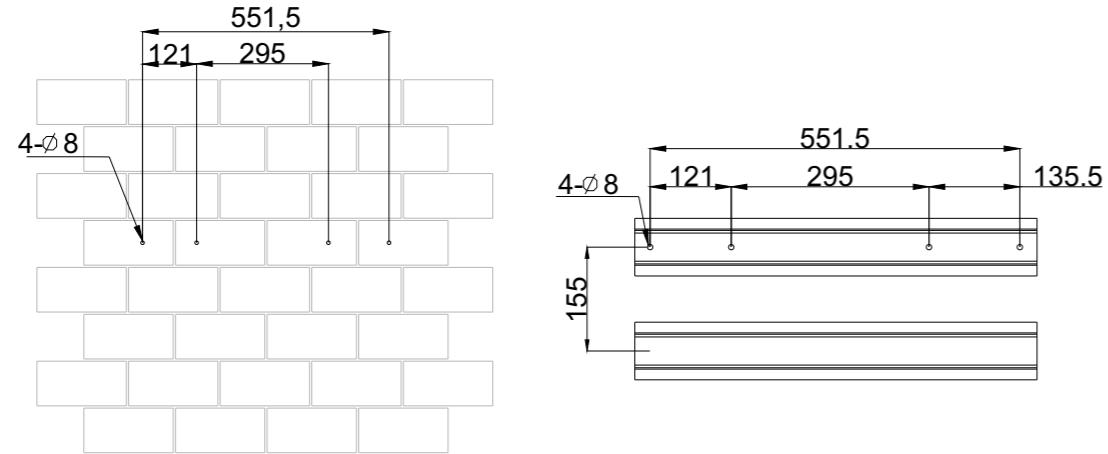

Figure 3.6  
Drill holes' dimensions of  
R6-25K/30K/33K/40K/50K-T4-32-AUS

**(3) Secure the Screws and the Rear Panel**

The panels should be secured onto the mounting position by screws as shown in Figure 3.7.

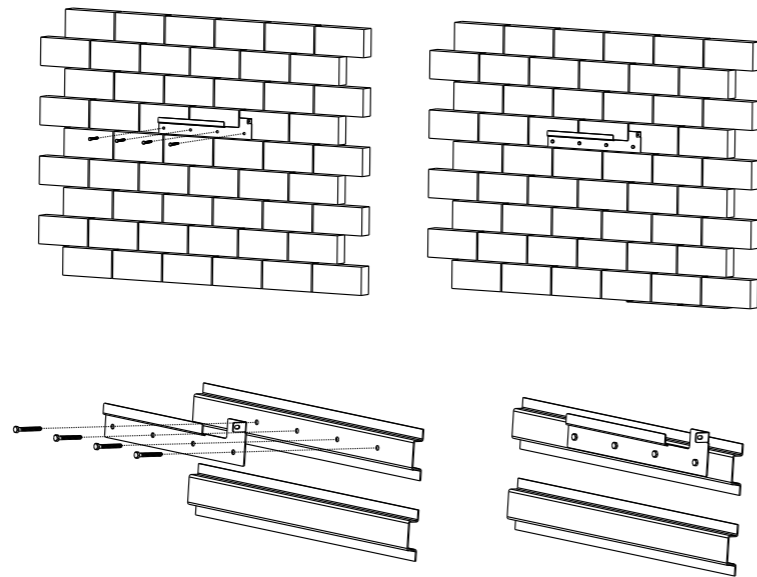

Figure 3.7  
Mount the rear panel

**(4) Mount the Inverter**

Carefully mount the inverter to the rear panel as shown in Figure 3.8 and 3.9. Make sure that the rear part of the equipment is closely mounted to the rear panel.

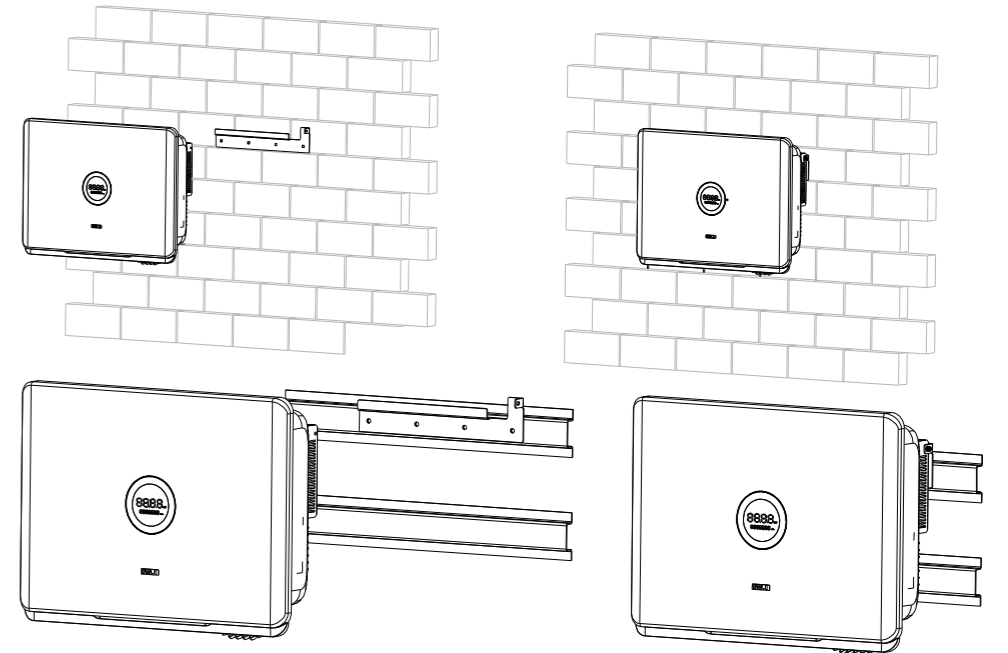

Figure 3.8  
Mount inverter

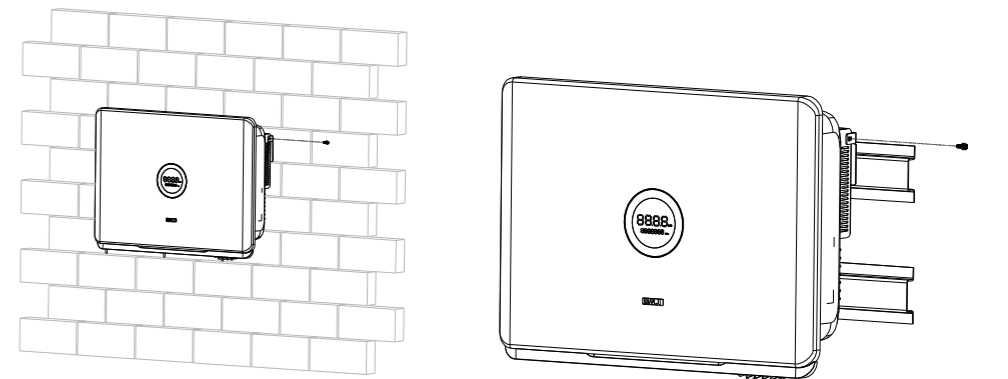

Figure 3.9  
Fasten the inverter and  
hanging panel with screws

## 4.

ELECTRICAL  
connection

## 4.1 Safety Instruction

Electrical connection must only be operated on by professional technicians. Please keep in mind that the inverter is a bi-power supply equipment. Before connection, necessary protective equipment must be employed by technicians including insulating gloves, insulating shoes and safety helmet.

 DANGER

- Dangerous to life due to potential fire or electricity shock.
- When power-on, the equipment should in conformity with national rules and regulations.
- The direct connection between the inverter and high voltage power systems must be operated by qualified technicians in accordance with local and national power grid standards and regulations.
- The PV arrays will produce lethal high voltage when exposed to sunlight.

 NOTICE

- Electrical connection should in conformity with proper stipulations, such as stipulations for cross-sectional area of conductors, fuse and ground protection.
- The overvoltage category on DC input port is II, on AC output port is III.
- When connecting or disconnecting any connectors, make use to use appropriate tools to avoid damage.

## 4.2 Earth Fault Alarm

This inverter complies with IEC 62109-2 clause 13.9 for earth fault alarm monitoring. If an Earth Fault Alarm occurs, the ring light will be lit up in red and error code <31> will be displayed on LED panel 1 until the error being solved and inverter functioning properly.

**NOTE:** The inverter cannot be used with functionally earthed PV Arrays.

### 4.3 Specifications for Electrical Interface

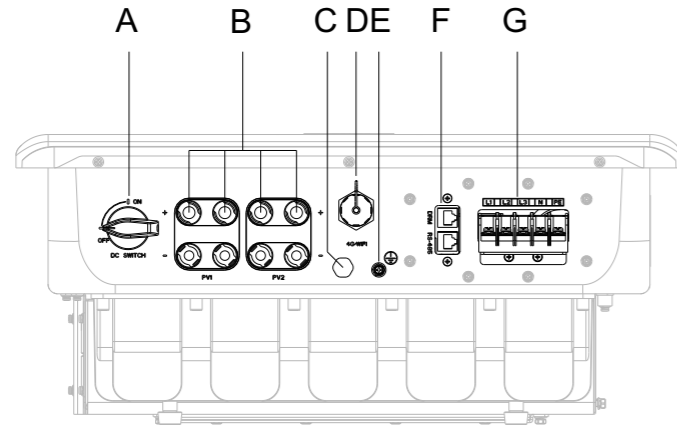

Figure 4.1  
Electrical interface of  
R6-8K/10K/15K/20K/25K-T2-32-AUS

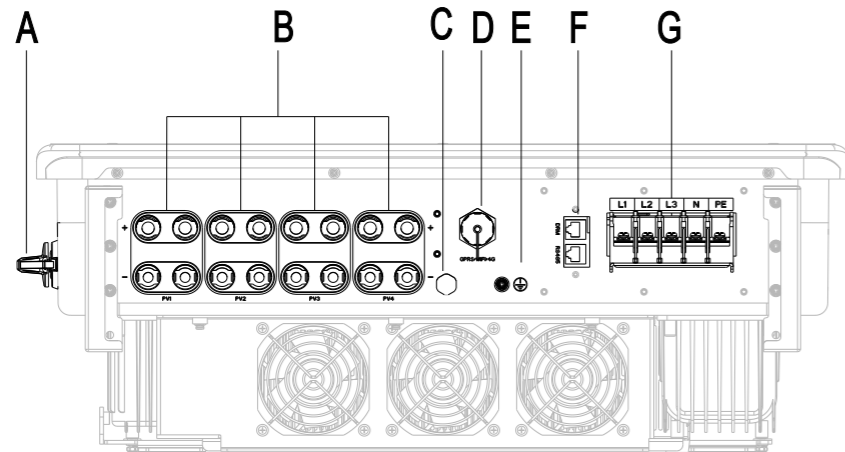

Figure 4.2  
Electrical interface of  
R6-25K/30K/33K/40K/50K-T4-32-AUS

Table 4.1  
Specifications for interface

Code	Name
A	DC Switch
B	DC Input
C	Decompression Valves
D	RS232 Communication
E	Ground Connection
F	RS485 Communication+DRM
G	Terminal Block

### 4.4 AC Connection

Table 4.2  
Recommended power grid connecting  
cable specification

Type	Cross-sectional area of cables (mm <sup>2</sup> )	
	Scope	Recommended value
R6-8K/10K/15K/20K/25K-T2-32-AUS	10.0-16.0	16.0
R6-25K/30K/33K/40K/50K-T4-32-AUS	16.0-35.0	25.0

If the grid-connection distance is too far, please select AC cable with larger diameter as per the actual condition.

(1)Ground of the inverter. After penetrating the external hex head screw through OT terminal of the grounding line, screw in the grounding port of enclosure of the inverter in clockwise direction and make sure it's screwed up tightly.

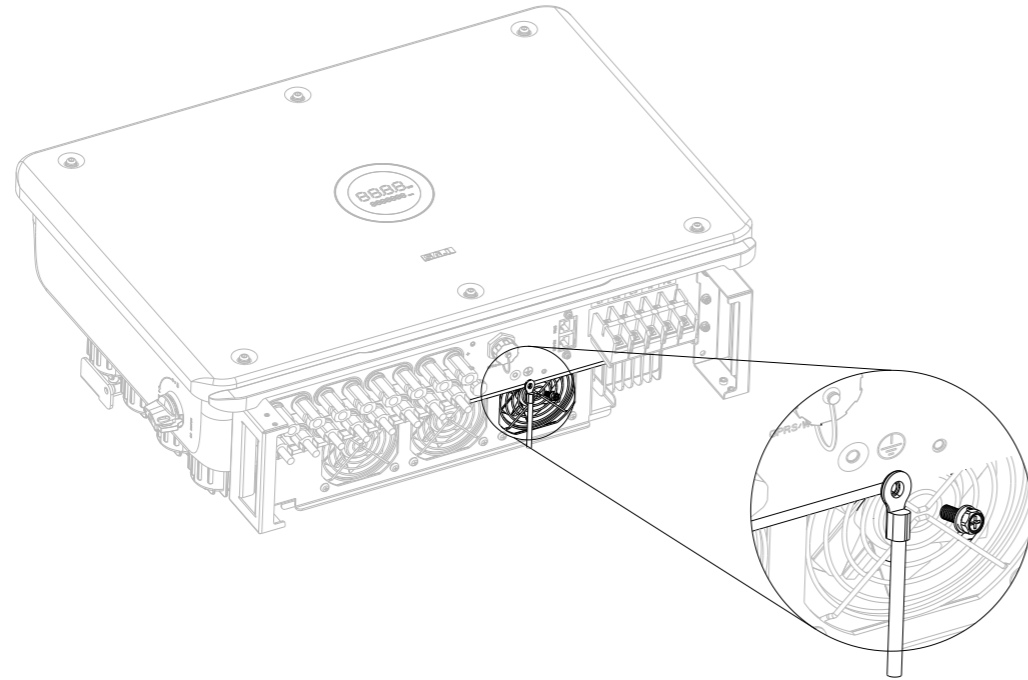

Figure 4.4  
Inverter ground protection

(2) Screw off the screws at the AC output wire cover and take out the cover. Penetrate the AC cable of which the insulation layers has been peeled off through the AC waterproof locking screw hole of the cover. Lock L1 wire, L2 wire, L3 wire, N wire and PE wire tightly as per the marked connection positions on the interface board.

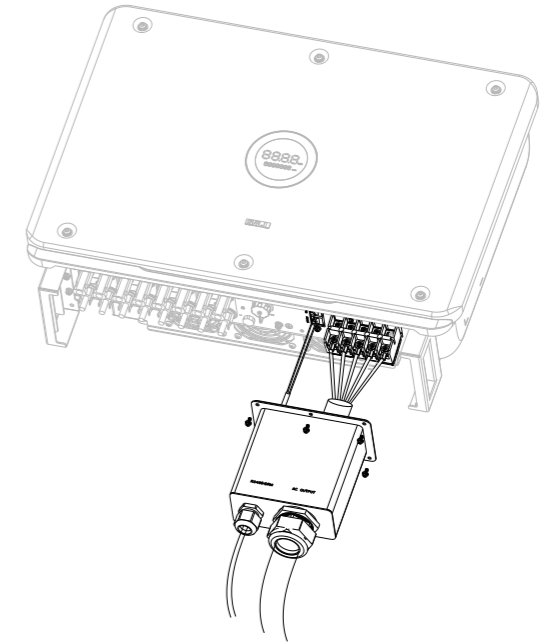

Figure 4.5  
Connect cable

(3) After fixing the cover at the AC output wire terminal with screws, tighten up the AC waterproof nut.

### External AC Circuit Breaker and Residual Current Device

Please install a 4P circuit breaker to ensure the inverter is able to disconnect from grid safely. The inverter is integrated with a RCMU, however, an external RCD is needed to protect the system from tripping, either type A or B RCD is compatible with the inverter. The integrated leakage current detector of inverter is able to detect the real time external current leakage. When a leakage current detected exceeds the limitation the inverter will be disconnected from grid quickly, if an external leakage current device is connected, the action current should be 300mA.

Table 4.3  
Recommended AC circuit breaker specifications

Type	Recommended AC circuit breaker specifications
R6-8K/10K/15K-T2-32-AUS	32A
R6-20K/25K-T2-32-AUS	50A
R6-25K/30K/33K/40K-T4-32-AUS	63A
R6-50K-T4-32-AUS	80A



## 4.5 DC Side Connection

Table 4.4  
Recommended specifications of DC cables

Cross-sectional area of cables (mm <sup>2</sup> )		Outside diameter of the cables (mm)
Scope	Recommended value	
4.0~6.0	4.0	4.2~5.3

DC connector is made up of one positive connector and one negative connector

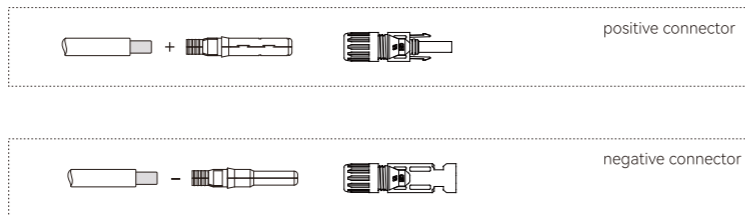

Figure 4.6  
Positive and negative connectors

**NOTICE**

- Please place the connector separately after unpacking in order to avoid confusion for connection of cables.
- Please connect the positive connector to the positive side of the solar panels, and connect the negative connector to the negative side of the solar side. Be sure to connect them in right position.

### Connecting Procedures:

(1) Use specified strip tool to strip the insulated enclosure of the positive and negative cables with appropriate length (8-10mm).

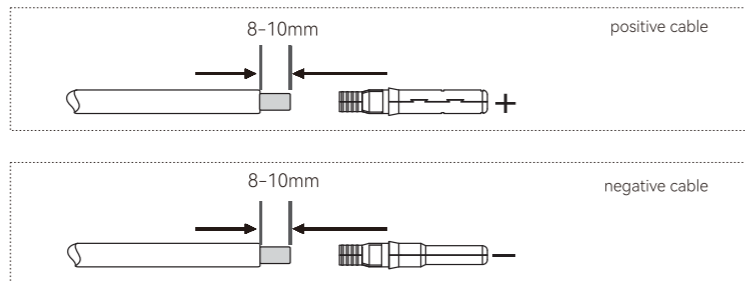

Figure 4.7  
Connecting Cables

(2) Feed the positive and negative cables into corresponding lock screws and crimp them tightly with a wire crimper. Make sure that the withdrawal force of the pressed cable is larger than 400N.

(3) Plug in the pressed positive and negative cables into relevant insulated enclosure, a "click" sound should be heard when the contact cable assembly is seated correctly.

(4) Fasten the lock screws on positive and negative connectors into corresponding insulated enclosure and make them tight.

(5) Connect the positive and negative connectors into positive and negative DC input terminals of the inverter, a "click" sound should be heard when the contact cable assembly is seated correctly.

Figure 4.8  
Connect the Inverter

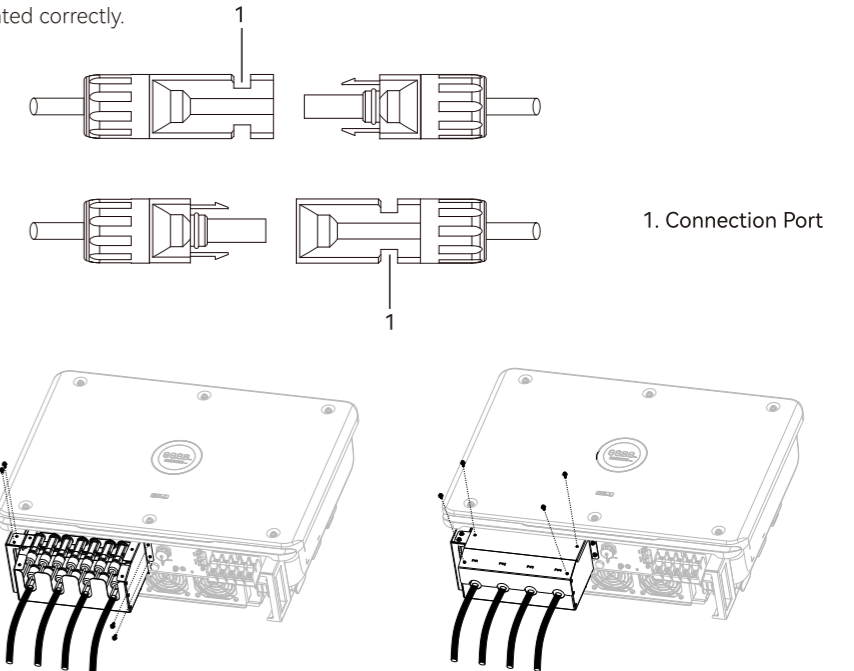

Figure 4.9  
Installation method of PV shell

**NOTICE**

- Before insert the connector into DC input terminal of the inverter, please make sure that the DC switch of the inverter is OFF. For further safety consideration, it is suggested that a reliable tool (such as a lock with a key) be used to lock the switch and make sure that others cannot unlock it easily.
- Please use the original terminal to install.

## 4.6 Communication Connection

R6 inverter is standardly equipped with a RS485 interface and a RS232 interface.

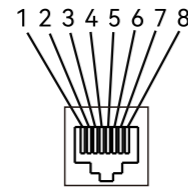

Figure 4.9  
RS485 pin

Table 4.5  
RS485 pin port definition

Pin Number	Description	Effect
1	NC	
2	NC	
3	NC	
4	NC	
5	NC	
6	NC	
7	RS485-A	Transmission RS485 differential signal
8	RS485-B	Transmission RS485 differential signal



Figure 4.10  
RS232 pin

Table 4.6  
USB pin port definition

Pin Number	Description	Effect
1	+7V	Power supply
2	RS-232 TX	Send data
3	RS-232 RX	Receive data
4	GND	Ground wire

(1) USB interface could be externally connected with eSolar AIO3 module, for operation in details please refer to eSolar AIO3 module Quick Installation Guide in [www.saj-electric.com](http://www.saj-electric.com)

(2) USB interface could be externally connected with eSolar 4G module, for operation in details please refer to eSolar 4G module Quick Installation Guide in [www.saj-electric.com](http://www.saj-electric.com)

(3) USB interface could be externally connected with eSolar WiFi module, for operation in details please refer to eSolar WiFi module Quick Installation Guide in [www.saj-electric.com](http://www.saj-electric.com)

To comply with Australian and New Zealand safety requirements, the DRMs terminals should be connected. DRM0 is supported. A RJ45 plug is being used as the inverter DRED connection.

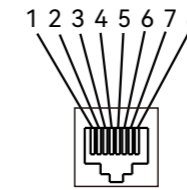

Figure 4.11  
DRM pin

Table 4.7  
Demand Response Modes (DRM)

Pin NO.	Name
1	NC
2	NC
3	NC
4	NC
5	REF GEN
6	COM LOAD
7	NC
8	NC

Table 4.8  
DRM0 mode

Mode	Corresponding pins	Requirement
DRM0	5 & 6	The inverter is on standby mode

## 4.7 Multiple Inverter Combinations

Section Multi-inverter combinations. A maximum of 10 inverters can be paralleled. If such multiple inverter combination is not tested, it should not be used or external devices should be used in accordance with the requirements of AS/NZS 4777.1

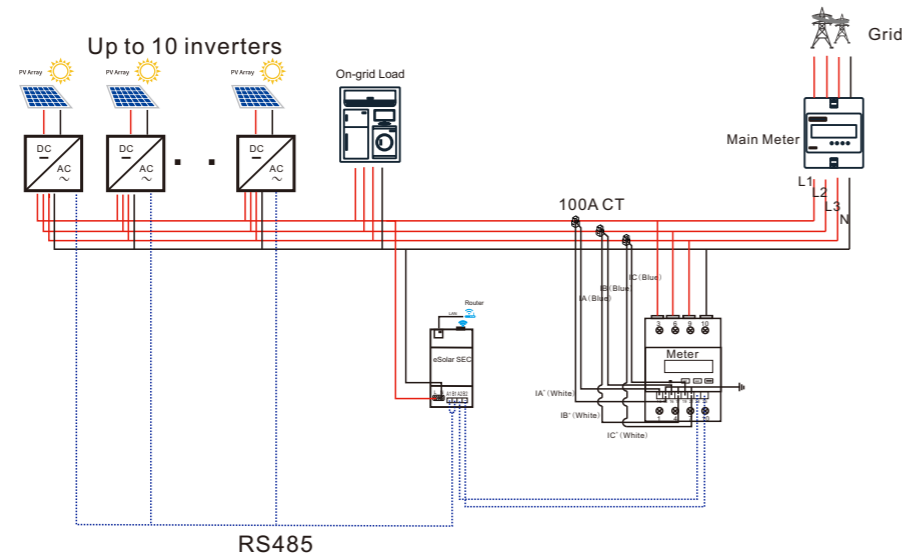

Figure 4.12  
Multiple Inverter Combinations

## 4.8 Start up and Shut down Inverter

### 4.8.1 Start Up the Inverter

1. Follow the installation standard from previous chapter strictly to connect the photovoltaic panels and AC power grid to inverter.
2. Using multimeter to check whether AC side and DC side voltage have met the inverter start voltage.
3. Turn ON DC switch (if applicable), LED indicators will be lit up.
4. Select country grid code through the APP (See Chapter 5 Monitoring Operations), please contact your local grid operator for which region to select. Inverter will be in self-testing, if inverter has met all the grid connecting condition, inverter will connect to grid and generate power automatically.

### 4.8.2 Shut Down the Inverter

1. Automatically shut down, when the solar light intensity is not strong enough during sunrise and sunset or the output voltage of photovoltaic system is less than the minimum input power of inverter, inverter will shut down automatically.
2. Shut down manually, disconnect AC side circuit breaker first, if multiple inverters are connected, disconnect the minor circuit breaker prior to disconnection of main circuit breaker. Disconnect the DC switch after inverter has reported grid connection lost alarm.

## 4.9 AFCI

The inverter is equipped with arc-fault circuit interrupter (AFCI). With AFCI protection, when there is an arc signal on the DC side due to aging of the cable or loose contact, R6 series can quickly detect and cut off the power to prevent fire, making the PV system run more safely.

## 5.1 Introduction of HMI (Human-Machine Interface)

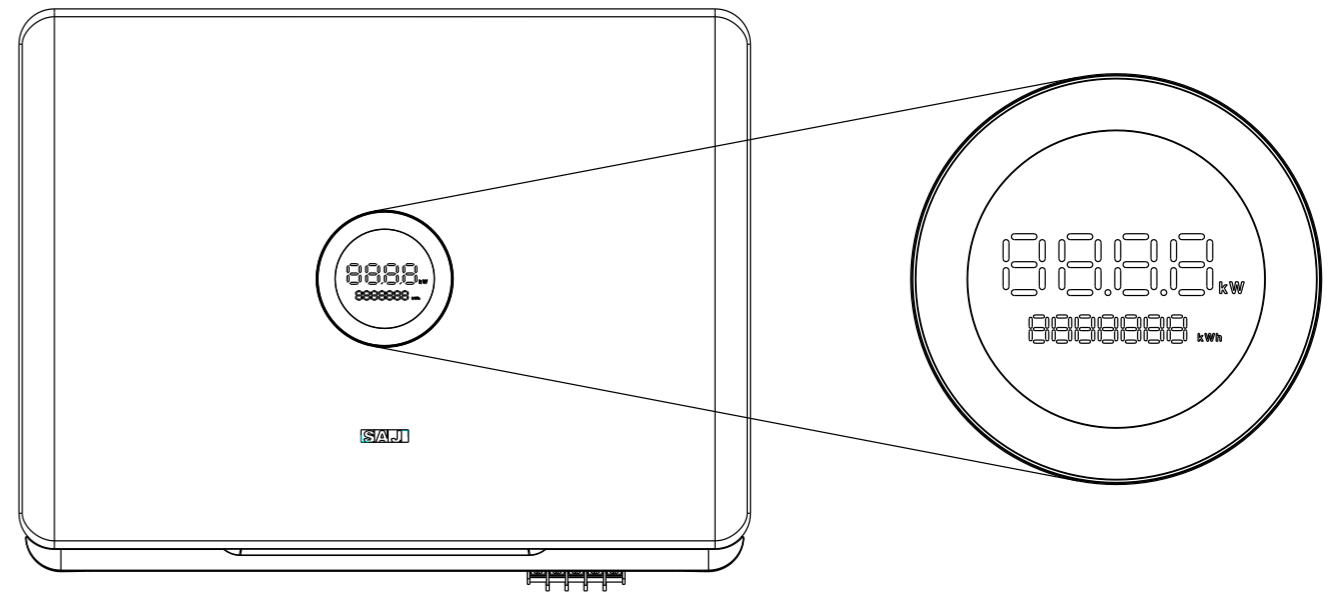

Figure 5.1  
Human-Machine Interface

# 5.

# DEBUGGING

instructions



Display	Status	Description	
Ring Light	○	Solid Green	The inverter is in normal on-grid state
		Breathing Mode	The inverter is in the initialization or waiting state
	○	Solid Red	An error occurs
		Breathing Mode	Software is upgrading in the inverter
	○	OFF	Power off
LED Panel 1	8888. / E036	Current power (kW) / Error code	
LED Panel 2	888888 kWh	Total yield (kWh)	

Table 5.1  
Interface description

## 5.2 Monitoring Operation

There is no LCD display screen in R6 series products and they could be monitored through eSAJ APP.

### 5.2.1 Downloading the eSAJ Home App

1. The eSAJ Home App can be used for both nearby and remote monitoring. It supports AIO3, 4G and Wi-Fi module to communicate with the device.
2. On your mobile phone, search for "eSAJ Home" in the App store and download the App.

### 5.2.2 Logging in to the App

1. Open the App and click on the three-dot icon  on the top right corner.
2. Set the Language to English and Network Node to Overseas Node.

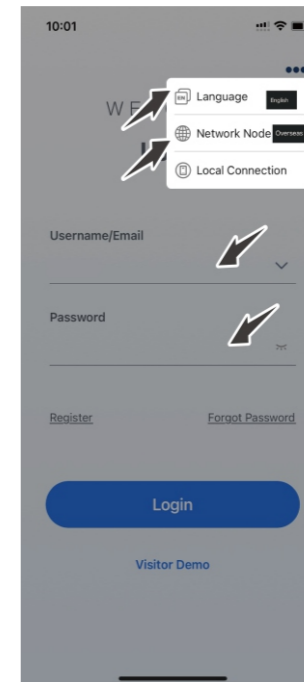

3. If you do not have an account, register first.
  - a. Click Register. Choose whether you are an owner or an installer or distributor.
  - b. Follow the instructions on the screen to complete the registration.
4. Use the account and password to log in to the App.
5. Go to the Tool interface and select Remote Configuration. Click on Bluetooth and enable the Bluetooth function on your mobile phone. Then, click on Next.

### 5.2.3 Completing the Initialization Settings

Follow the instructions on the screen.

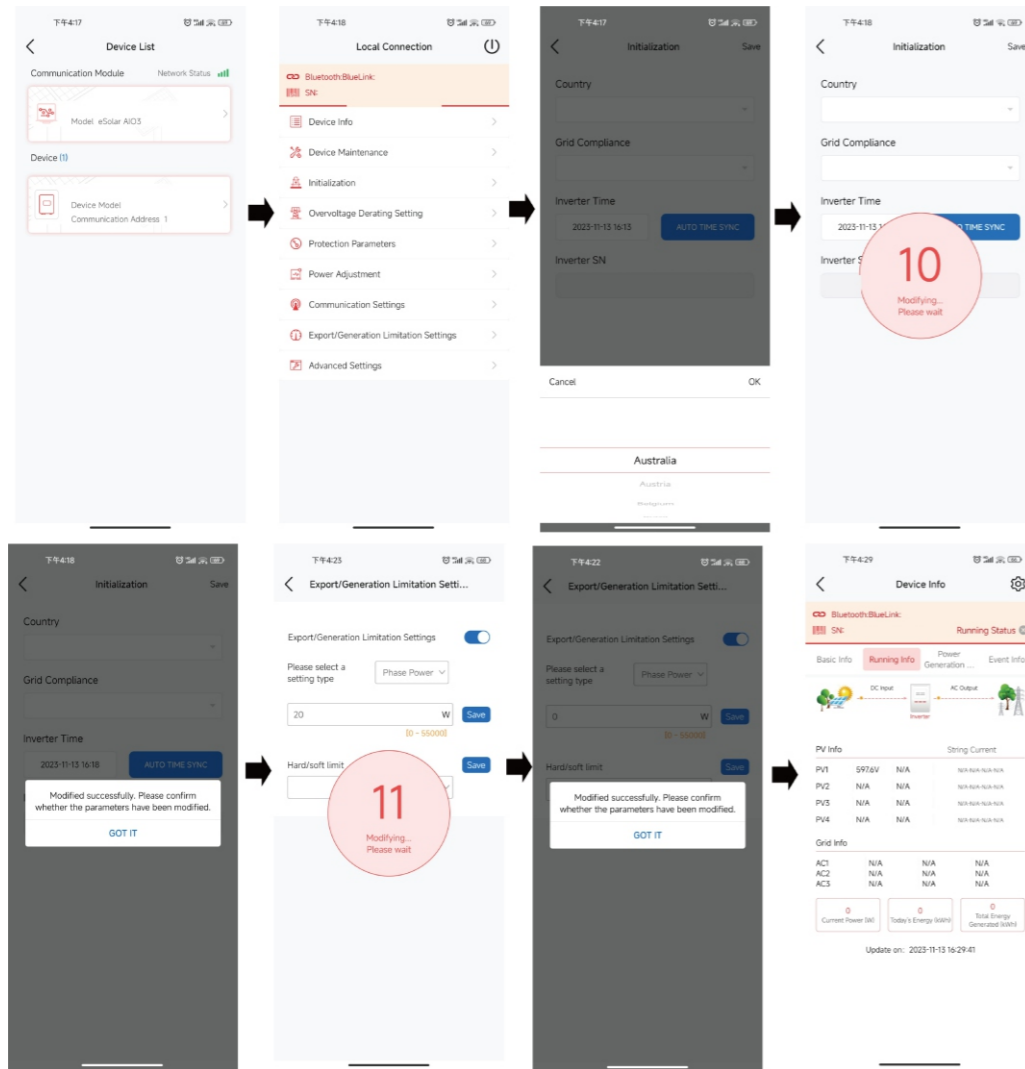

### 5.2.4 Protection Parameter Setting

Corresponding modification of protection parameters will take effect only after saving.

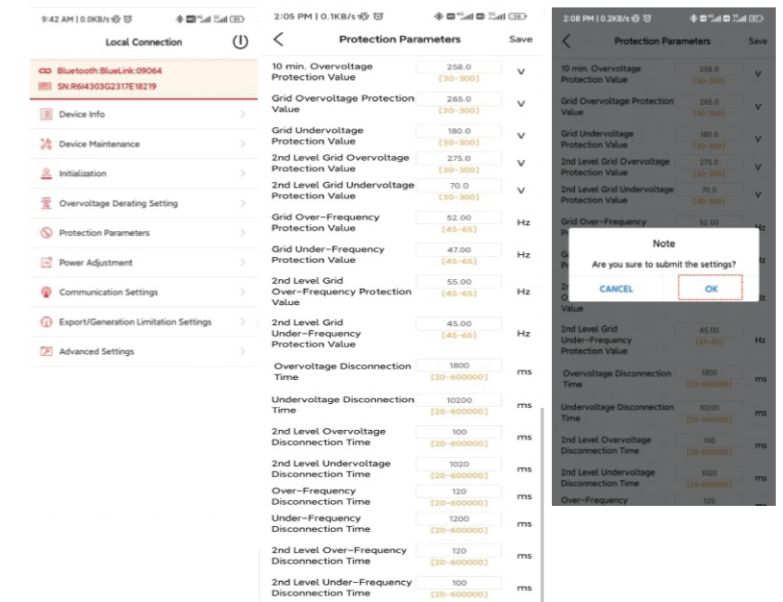

### 5.2.5 Inverter Setting Review

After commissioning, the device info including device basic info, running info and event info can be viewed. Country and grid code can be viewed from initial setting.

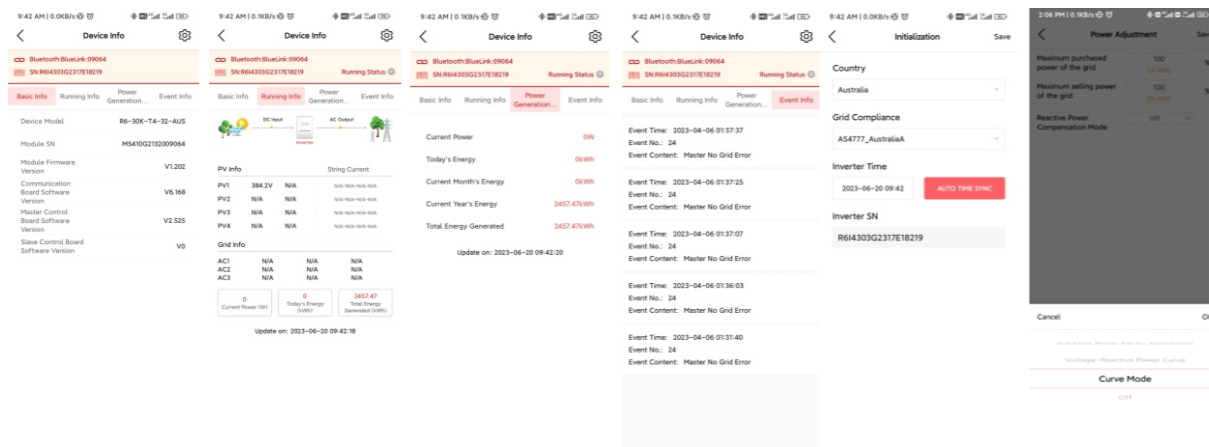

### 5.2.6 Remote Monitoring

Connect the internet via the eSolar/4G/WiFi module, and upload the inverter data onto the server and customers could monitor running information of the inverter remotely via the eSolar Web Portal or their mobile customer terminals.

For details, refer to the user manual of the communication module.

## 5.3 Setting Reactive Power Control(for Australia)

### 5.3.1 Setup Fixed Power Factor Mode & Fixed Reactive Power Mode

#### Fixed Power Factor Mode

**Step 1:** Select Power Adjustment and enter password “201561”.

**Step 2:** Select Capacitive Power Factor or Inductive Power Factor according to your local grid regulation. The power factor range is from 0.8 leading ~ 0.8 lagging.

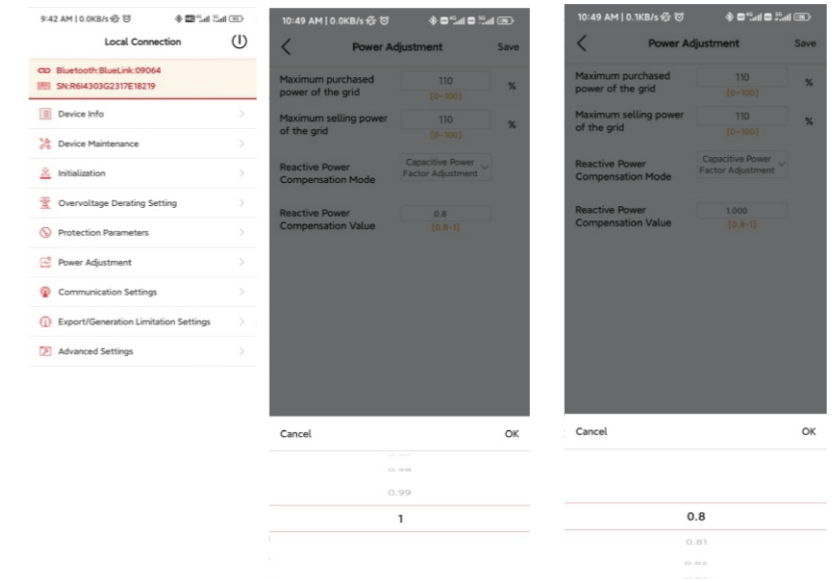

## Fixed Reactive Power Mode

**Step 1:** Select Inductive Adjustment Var or Capacitive Var according to your local grid regulation. The power range is from  $-60\%P_n \sim 60\%P_n$ .

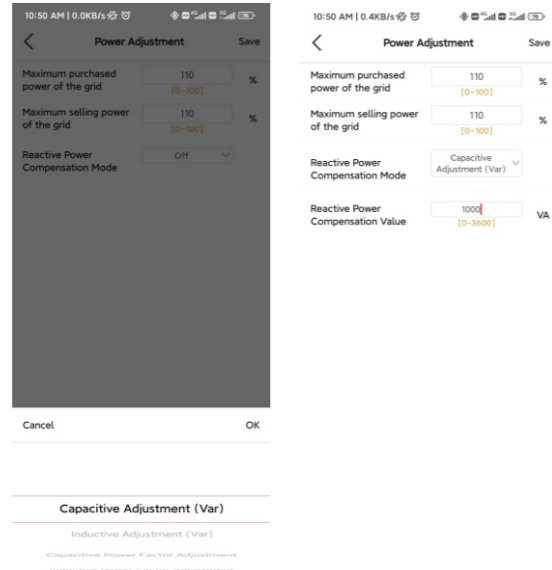

## 5.3.2 Setup V-Watt and volt-Var mode

This inverter complies with AS/NZS 4777. 2020 for power quality response modes. The inverter satisfies different regions of DNSPs' grid connection rules requirements for volt-watt and volt-var Settings. e.g.: AS4777 series setting as below Fig 5.5&5.6.

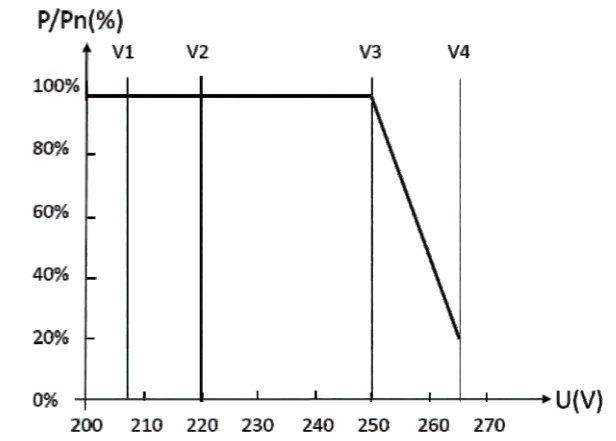

Figure 5.5  
Curve for a Volt-Watt response mode (AS4777 Series)

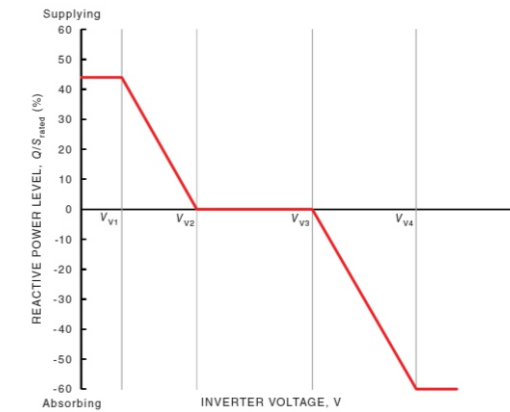
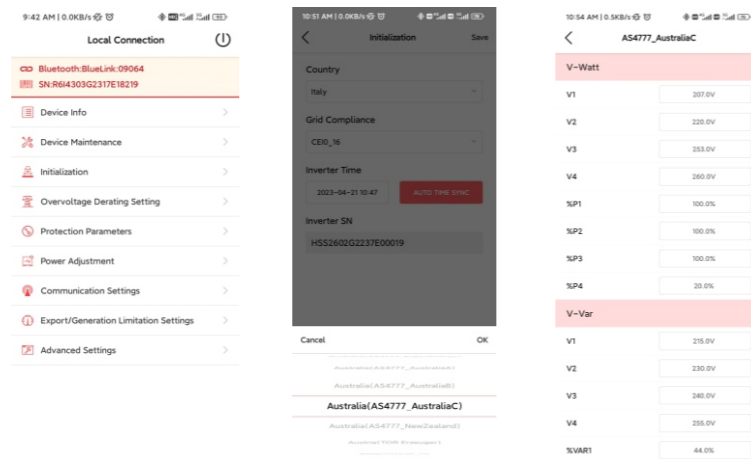

Figure 5.6  
Curve for a Volt-Var control mode (AS4777 Series)



**Setting procedure:**

1. AS4777 grid compliance has been set during production, please select corresponding grid compliance according to state regulation during installation. You can choose a state regulation compliance with your local grid via eSAJ Home.
2. Log in to eSAJ Home. For connection procedure please refer to chapter 5.2 Monitoring Operation.
3. Click "V-Watt/V-Var" to enter DNSPs settings, choose a suitable state regulation from the drop down list.



**NOTE:**

With regard to the Power rate limit mode, SAJ sets the product WGrA to 16.67%Pn by default in the following cases according to the requirements of 3.3.5.2 as 4777.2: 2020.

1. Soft ramp up after connect,
2. Reconnect or soft ramp up/down following a response to frequency disturbance.

## 5.4 Export Limit Setting

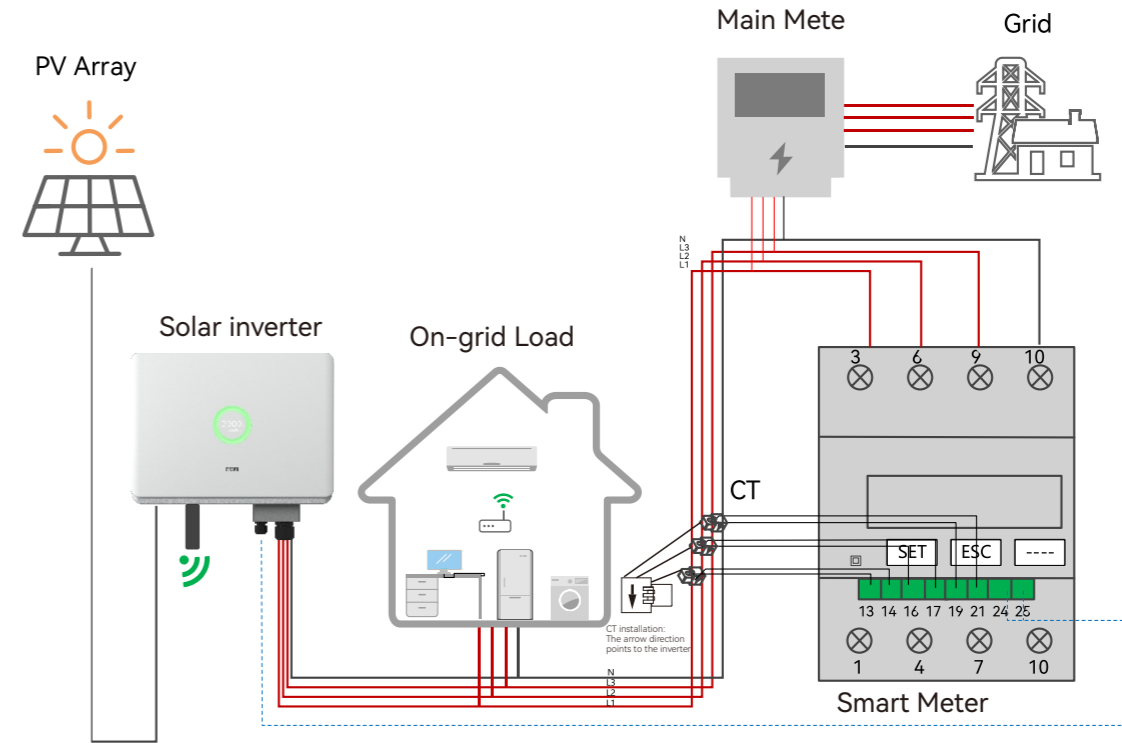
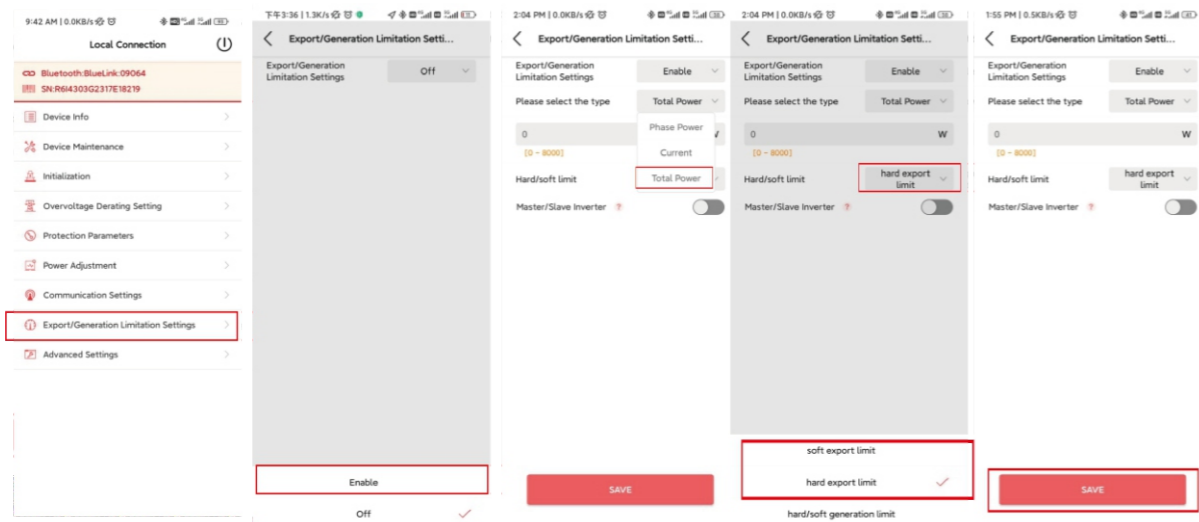

Figure 5.4  
Export limit wiring schematic

### 5.3.1 APP Setting

- Step 1: click Export/Generation Limitation Settings.
- Step 2: Enable Export Limit.
- Step 3: choose "Total Power"
- Step 4: click Hard/soft Limit Select control mode.
- Step 5: Click "SAVE" Save Settings.



### 5.5 Self-test (For Italy)

Italian Standard CEI0-21 requires a self-test function for all inverter that connected to utility grid. During the self-testing time, inverter will check the reaction time for over frequency, under frequency, overvoltage and undervoltage. This self-test is to ensure the inverter is able to disconnect from grid when required. If the self-test fails, the inverter will not be able to feed into the grid.

- Step1:** Connect a communication module (Wi-Fi/4G/Ethernet) with inverter (connection procedure can refer to eSolar Module Quick Installation Manual)
- Step2:** Select Italy for Country and choose your corresponding Grid Code from Initial Setting.

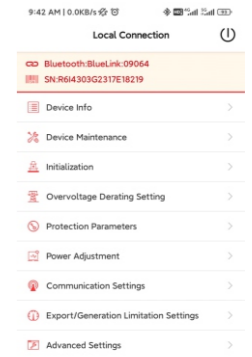

**Step 3: Start Self-test**

You can choose self-test item required. Individual self-test time is approx. 5 minutes. All self-test time is approx. 40 minutes. After the self-test is completed, you can save the test report. If self-test is failed, please contact with SAJ or your inverter supplier.

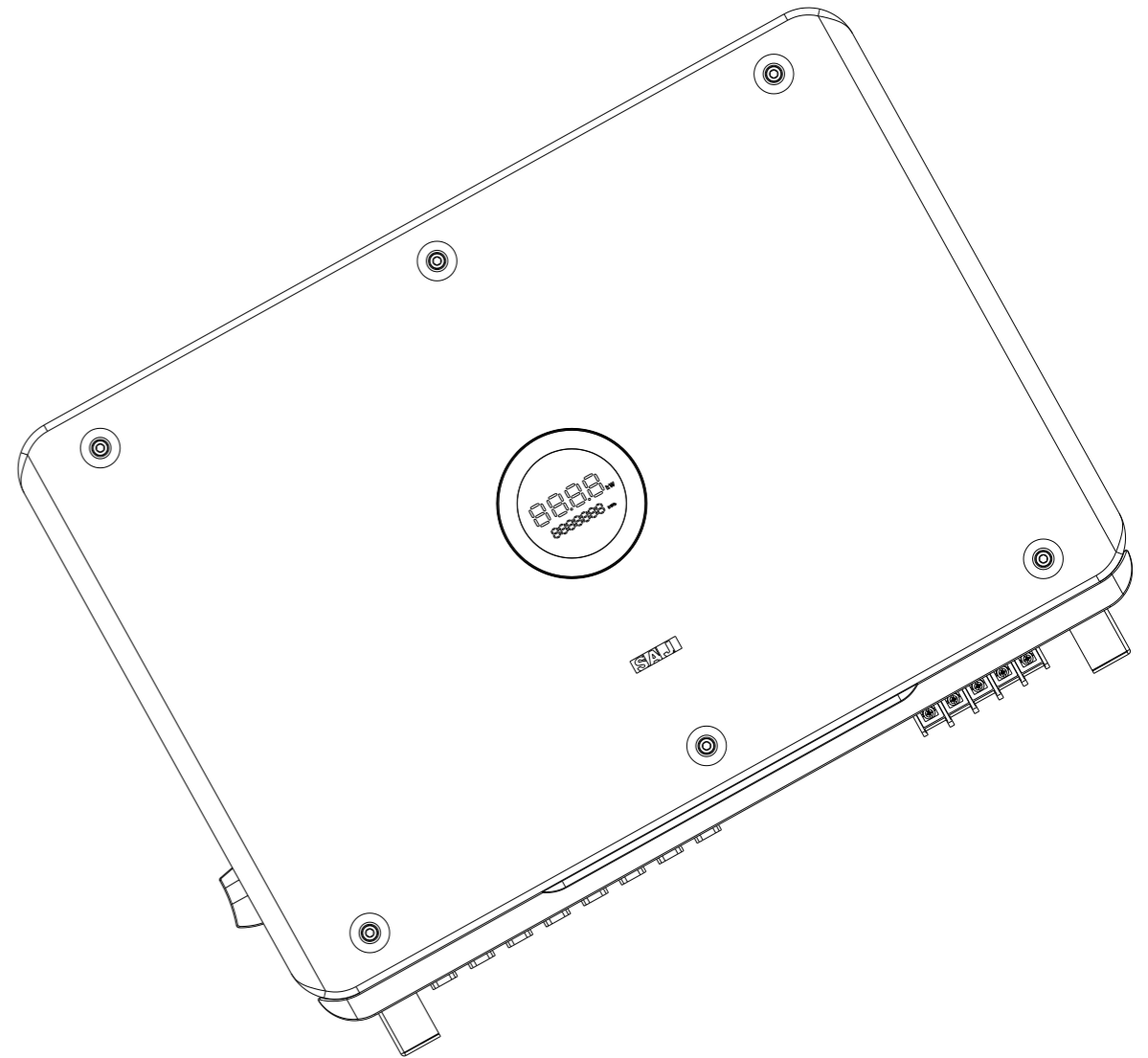
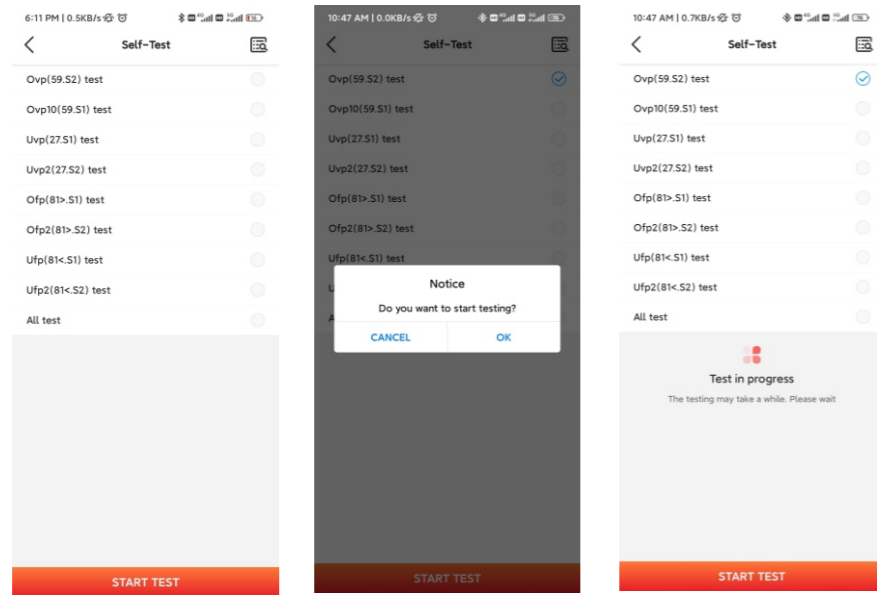



# Fault Code & Troubleshooting



## Troubleshooting

Code	Fault Information
1	Master Relay Error
2	Master EEPROM Error
3	Master Temperature High Error
4	Master Temperature Low Error
5	Lost Communication M<->S
6	GFCI Device Error
7	DCI Device Error
8	Current Sensor Error
9	Master Phase1 Voltage High
10	Master Phase1 Voltage Low
11	Master Phase2 Voltage High
12	Master Phase2 Voltage Low
13	Master Phase3 Voltage High
14	Master Phase3 Voltage Low
15	Grid Voltage 10Min High
16	OffGrid Output Voltage Low
17	OffGrid Output Short Circuit
18	Master Grid Frequency High
19	Master Grid Frequency Low
21	Phase1 DCV High
22	Phase2 DCV High
23	Phase3 DCV High
24	Master No Grid Error
27	GFCI Error
28	Phase1 DCI Error
29	Phase2 DCI Error
30	Phase3 DCI Error
31	ISO Error
32	Bus Voltage Balance Error
33	Master Bus Voltage High
34	Master Bus Voltage Low
35	Master Grid Phase Lost
36	Master PV Voltage High
37	Master Islanding Error
38	Master HW Bus Voltage High
39	Master HW PV Current High

Code	Fault Information
40	Master Self-Test Failed
41	Master HW Inv Current High
42	Master AC SPD Error
43	Master DC SPD Error
44	Master Grid NE Voltage Error
45	Master Fan1 Error
46	Master Fan2 Error
47	Master Fan3 Error
48	Master Fan4 Error
49	Lost Communication between Master and Meter
50	Lost Communication between M<->S
51	Lost Communication between inverter and Grid Meter
52	HMI EEPROM Error
53	HMI RTC Error
54	BMS Device Error
55	BMS Lost.Conn
56	CT Device Err
57	AFCI Lost Err
58	Lost Com. H<->S Err
61	Slave Phase1 Voltage High
62	Slave Phase1 Voltage Low
63	Slave Phase2 Voltage High
64	Slave Phase2 Voltage Low
65	Slave Phase3 Voltage High
66	Slave Phase3 Voltage Low
67	Slave Frequency High
68	Slave Frequency Low
73	Slave No Grid Error
74	Slave PV Input Mode Error
75	Slave HW PV Curr High
76	Slave PV Voltage High
77	Slave HW Bus Volt High
81	Lost Communication D<->C
83	Master Arc Device Error
84	Master PV Mode Error

Code	Fault Information
85	Authority expires
86	DRM0 Error
87	Master Arc Error
88	Master SW PV Current High

Talbe 6.1  
Error Code

Please contact your supplier for troubleshooting and remedy

General troubleshooting methods for inverter are as follows:

Fault Information	Troubleshooting
Relay Error	If this error occurs frequently, please contact your distributor or call SAJ technical support.
Storer Error	If this error occurs frequently, please contact your distributor or call SAJ technical support.
High Temperature Error	Check whether the radiator is blocked, whether the inverter is in too high or too low temperature, if the above mentioned is in normal, please contact your distributor or call SAJ technical support.
Master Lost Communication	If this error occurs frequently, please contact your distributor or call SAJ technical support.
GFCI Devices Error	If this error occurs frequently, please contact your distributor or call SAJ technical support.
DCI Devices Error	If this error occurs frequently, please contact your distributor or call SAJ technical support.
Current Sensor Error	If this error occurs frequently, please contact your distributor or call SAJ technical support.
AC Voltage Error	<ul style="list-style-type: none"> <li>· Check the volt. of the grid</li> <li>· Check the connection between the inverter and the grid.</li> <li>· Check the settings of the on-grid standards of the inverter.</li> <li>· If the volt. of the grid is higher than the volt. regulated by local grid, please inquire the local grid workers whether they can adjust the volt. at the feed point or change the value of the regulated volt.</li> <li>· If the volt. of the grid is in regulated range as allowed and LCD still in this error, please contact your distributor or call SAJ technical support.</li> </ul>

Talbe 6.2  
Troubleshooting

Fault Information	Troubleshooting
Frequency Error	Check the setting of country and check the frequency of the local grid. If the above mentioned are in normal, please contact your distributor or call SAJ technical support.
Grid Lost Error	Check the connection status between the AC side of the inverter and the grid, if the above mentioned are in normal, please contact your distributor or call SAJ technical support.
GFCI Error	Check the insulation resistance of the positive side and negative side of the solar panel; check whether the inverter is in wet environment; check the grounding of the inverter. If the above mentioned are in normal, please contact your distributor or call SAJ technical support.
DCI Error	If this error exists always, please contact your distributor or call SAJ technical support.
ISO Error	Check the insulation resistance of the positive side and negative side of the solar panel; check whether the inverter is in wet environment; check whether the grounding of the inverter is loose or not. If the above mentioned are in normal, please contact your distributor or call SAJ technical support.
Overcurrent	Check the connection status between the inverter and the grid and test whether the volt. of the grid is stable or not, if the above mentioned are in normal, please contact your distributor or call SAJ technical support.
Over Bus Voltage	Check the settings of the solar panel. SAJ designer can help you. If the above mentioned are in normal, please contact your distributor or call SAJ technical support.
PV Overcurrent	If this error always exists, please contact your distributor or call SAJ technical support.
PV Voltage Fault	Check the settings of the solar panel. SAJ designer can help you. If the above mentioned are in normal, please contact your distributor or call SAJ technical support.
Lost Communication	Check the connection of communication cables between control board and display board. If the above mentioned are in normal, please contact your distributor or call SAJ technical support.
Null line-to-earth voltage fault	Check if connection of the AC output grounding terminal is stable and reliable. If the content mentioned as above is normal, please contact your distributor or call SAJ technical support.

# 7.

## TRANSPORTATION & Disposal



### 7.1 Transportation

Take care of the product during transportation and storage, keep less than 7 cartons of inverter in one stack.

### 7.2 Recycling and Disposal



This device should not be disposed as residential waste. An Inverter that has reached the end of its life and is not required to be returned to your dealer, it must be disposed carefully by an approved collection and recycling facility in your area.

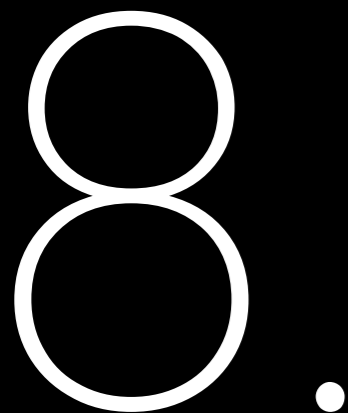

# ROUTINE MAINTENANCE



## Inverter Cleaning

Clean the enclosure lid and LED indicator of the inverter with moistened cloth with clear water only. Do not use any cleaning agents as it may damage the components.

## Heat Sink Cleaning

Clean the heat sinks with dry cloth or air blower. Do not clean the heat sink with water or cleaning agents. Make sure there is enough space for ventilation of inverter.