



GUANGZHOU SANJING ELECTRIC CO.,LTD



Tel: (86)20 66608588 Fax: (86)20 66608589 Web: www.saj-electric.com
Add: SAJ Innovation Park, No.9, Lizhishan Road, Science City, Guangzhou High-tech Zone, Guangdong, P.R.China

V0.0

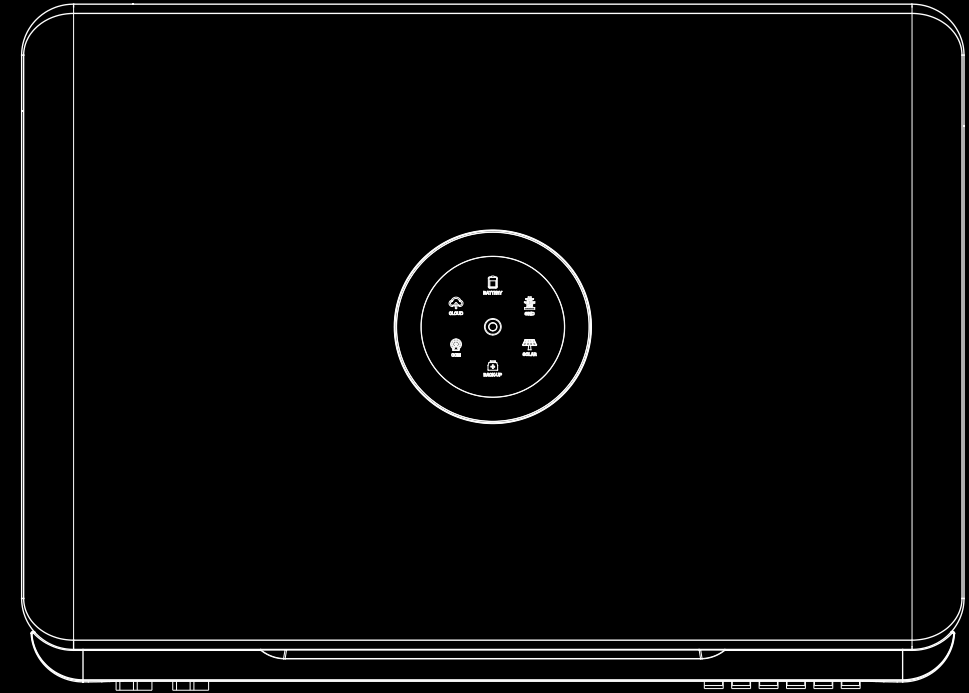

H2 series

SAJ HYBRID SOLAR INVERTER

instruction manual

H2-6K-S2-IE

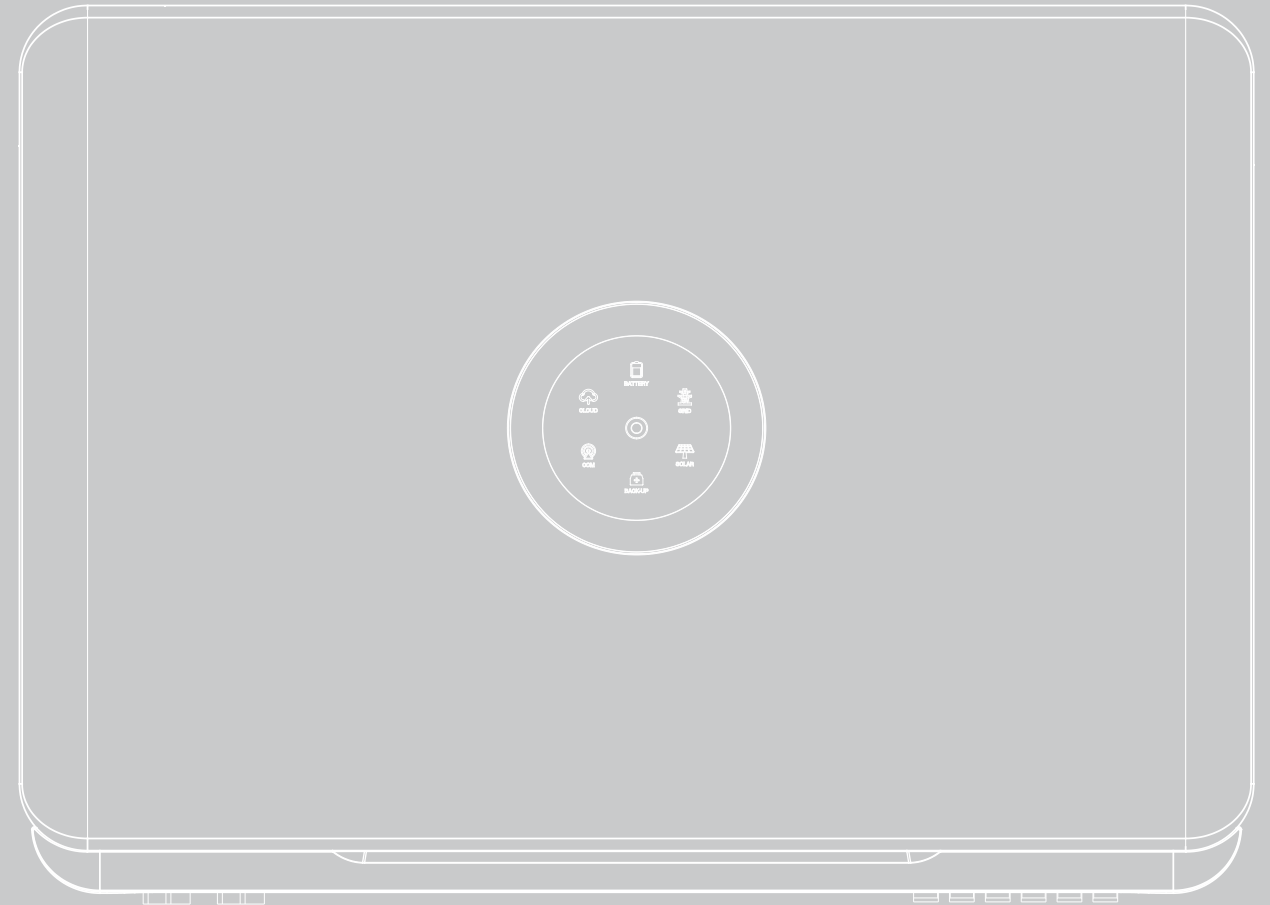

TABLE OF contents

1. SAFETY PRECAUTIONS-----	P1
1.1 Scope of Application -----	P2
1.2 Safety -----	P2
2. PRODUCT OVERVIEW -----	P5
2.1 Packing List -----	P7
2.2 Specification for Product Model-----	P8
2.3 Overview of Products-----	P8
2.4 Datasheet -----	P9
3. INSTALLATION NOTES -----	P11
3.1 The Determination of the Installation Position---	P12
3.2 Mounting Procedure -----	P14
4. ELECTRICAL CONNECTION -----	P17
4.1 Safety Instruction for Hot-line Job -----	P18
4.2 Specifications for Electrical Interface -----	P18
4.3 Ground Connection -----	P19
4.4 AC Grid Wire and Backup Output Connection---	P20
4.5 PV Connection-----	P21
4.6 Battery Connection-----	P24

4.7 Earth Fault Alarm-----	P26
4.8 Communication Connection -----	P26
4.9 System Connection-----	P28
4.10 Connection Diagram-----	P28
4.11 External AC Circuit Breaker and Residual Current Device-----	P30

5. DEBUGGING INSTRUCTIONS -----	P31
5.1 Start Up and Shut Down Inverter -----	P32
5.2 Introduction of LED Indicator-----	P32
5.3 Commissioning-----	P34
5.4 eSAJ APP Connection-----	P34
5.5 Working Modes-----	P37
5.6 Export Limit Setting-----	P38
5.7 Self-test (For Italy)-----	P39
5.8 Setting Reactive Power Control (For Australia)--	P41
6. FAULT CODE-----	P45
7. RECYCLING AND DISPOSAL-----	P47
8. TRANSPORTATION -----	P48
9. CONTACT SAJ-----	P48

1.

SAFETY precautions



1.1 Scope of Application

This User Manual describes instructions and detailed procedures for installing, operating, main-
taining, and troubleshooting of the following SAJ hybrid solar inverters:

H2-6K-S2-IE

Please read the user manual carefully before any installation, operation and maintenance and
follow the instruction during installation and operation. Please keep this manual all time avail-
able in case of emergency.

Only qualified electricians who have read and fully understood all safety regulations contained
in this manual can install, maintain and repair the inverter. Operators must be aware of the
high-voltage device.

1.2 Safety

1.2.1 Safety instruction









 DANGER
· DANGER indicates a hazardous situation, which, if not avoided, will result in death or serious injury.

 WARNING
· WARNING indicates a hazardous situation, which, if not avoided, can result in death or serious injury or moderate injury.

 CAUTION
· CAUTION indicates a hazardous condition, which, if not avoided, can result in minor or moderate injury.

 NOTICE
· NOTICE indicates a situation that can result in potential damage, if not avoided.

1.2.2 Explanations of Symbols

Symbol	Description
	Dangerous electrical voltage This device is directly connected to public grid, thus all work to the inverter shall only be carried out by qualified personnel.
	Danger to life due to high electrical voltage! There might be residual currents in inverter because of large capacitors. Wait 5 MINUTES before you remove the front lid.
	Notice, danger! This is directly connected with electricity generators and public grid.
	Danger of hot surface The components inside the inverter will release a lot of heat during operation. Do not touch metal plate housing during operating.
	An error has occurred Please go to Chapter 9 "Troubleshooting" to remedy the error.
	This device SHALL NOT be disposed of in residential waste Please go to Chapter 8 "Recycling and Disposal" for proper treatments.
	CE Mark With CE mark & the inverter fulfills the basic requirements of the Guideline Governing Low-Voltage and Electro-magnetic Compatibility.
	RCM Mark Equipment meets safety and other requirements as required by electrical safety laws/regulations in Australian and New Zealand.

1.2.3 Safety Instructions



- There is possibility of dying due to electrical shock and high voltage.
- Do not touch the operating component of the inverter; it might result in burning or death.
- To prevent risk of electric shock during installation and maintenance, please make sure that all AC and DC terminals are plugged out.
- Do not touch the surface of the inverter while the housing is wet, otherwise, it might cause electrical shock.
- Do not stay close to the inverter while there are severe weather conditions including storm, lightning, etc.
- Before opening the housing, the SAJ inverter must be disconnected from the grid and PV generator, you must wait for at least five minutes to let the energy storage capacitors completely discharged after disconnecting from power source.

 **WARNING**

- The installation, service, recycling and disposal of the inverters must be performed by qualified personnel only in compliance with national and local standards and regulations.
- Any unauthorized actions including modification of product functionality of any form may cause lethal hazard to the operator, third parties, the units or their property. SAJ is not responsible for the loss and these warranty claims.
- The SAJ inverter must only be operated with PV generator Do not connect any other source of energy to the SAJ inverter.
- Be sure that the PV generator and inverter are well grounded in order to protect properties and persons.

 **CAUTION**

- The inverter will become hot during operation. Please do not touch the heat sink or peripheral surface during or shortly after operation.
- Risk of damage due to improper modifications.

 **NOTICE**

- Public utility only.
- The inverter is designed to feed AC power directly to the public utility power grid; do not connect AC output of the inverter to any private AC equipment.

2.

PRODUCT overview



H2 Series

H2 series is a hybrid photovoltaic inverter and it is applicable to both on-grid and off-grid solar systems. The energy generated by PV system will be fed to loads first, and then the surplus energy can charge the battery for later use, if there is still excess more energy, it will be exported to the grid. H2 inverter can significantly improve the self-consumption rate of solar energy and lower the dependency on grid.

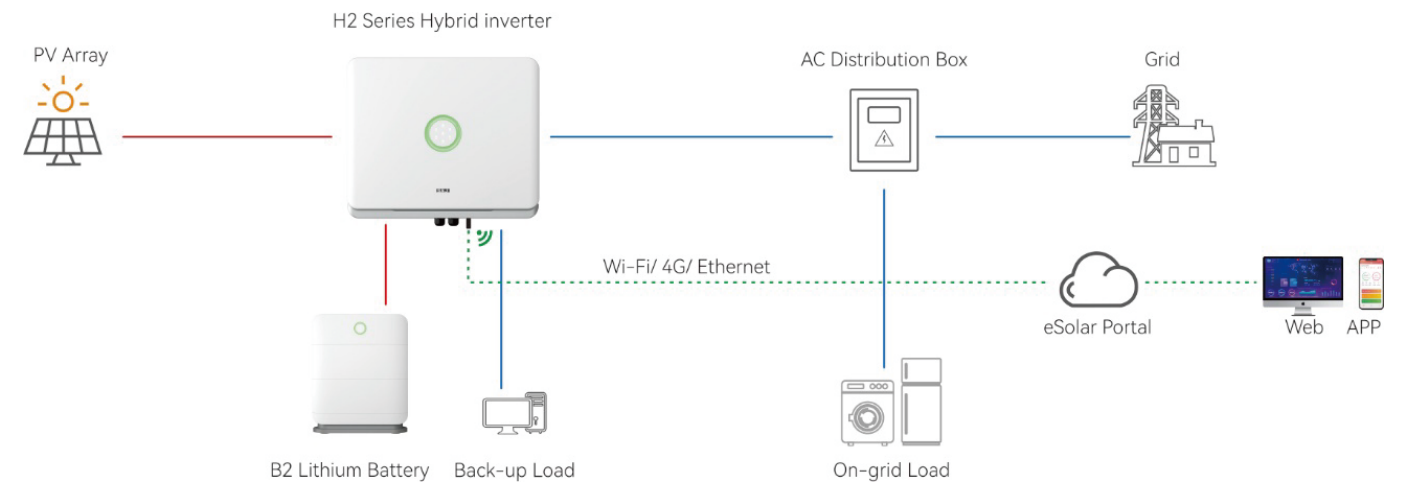
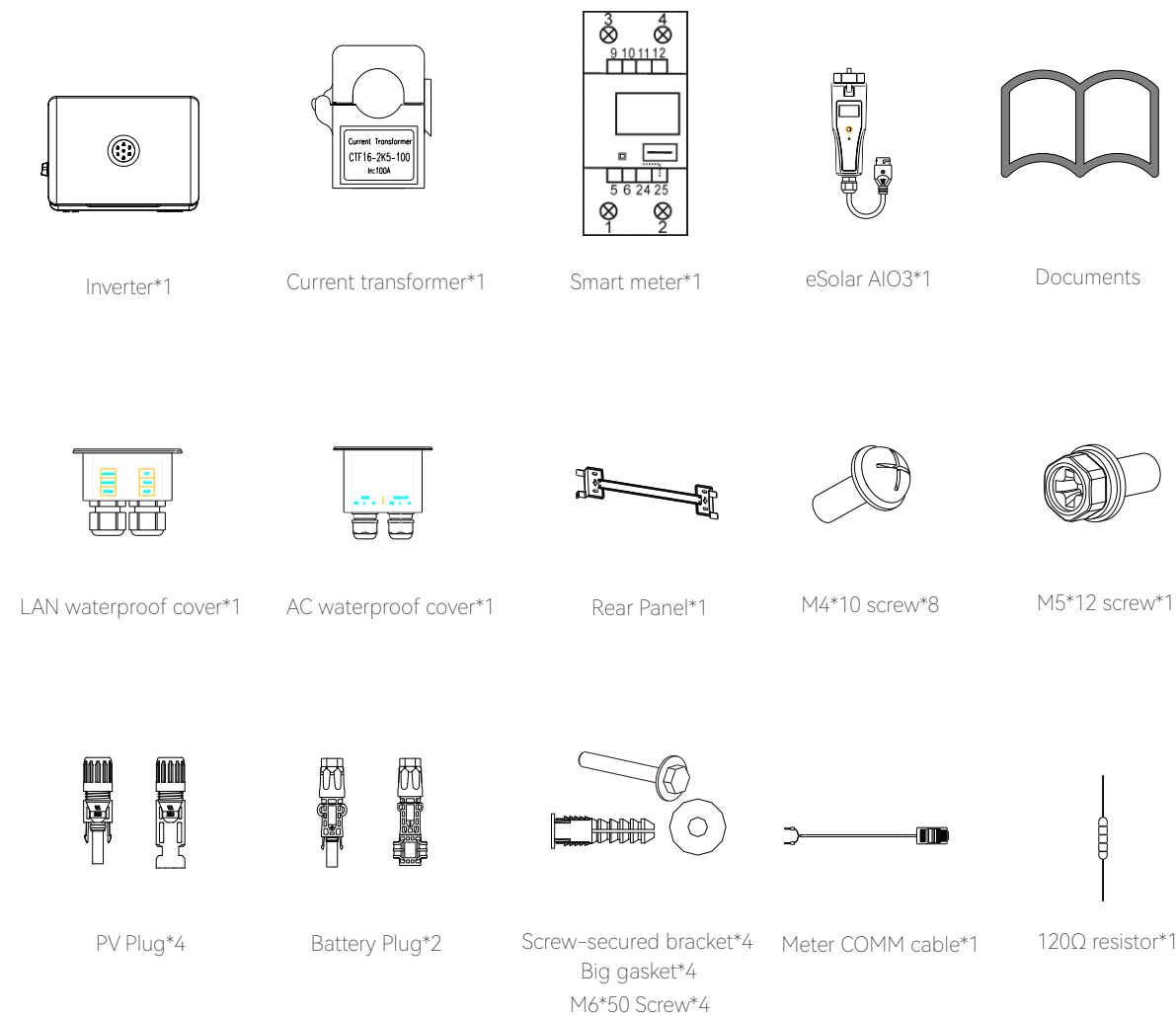

Figure 2.1
System overview

2.1 Packing List



2.2 Specification for Product Model

H2 - 6K - S2 - IE

① ② ③ ④

- ① H2 represents for product name.
- ② 6K represents rated power 6kW of inverter.
- ③ S2 means single phase with 2MPPT.
- ④ IE indicates this model is ONLY applicable to Ireland.

2.3 Overview of Products

Figure 2.2
Dimensions of H2 series Product

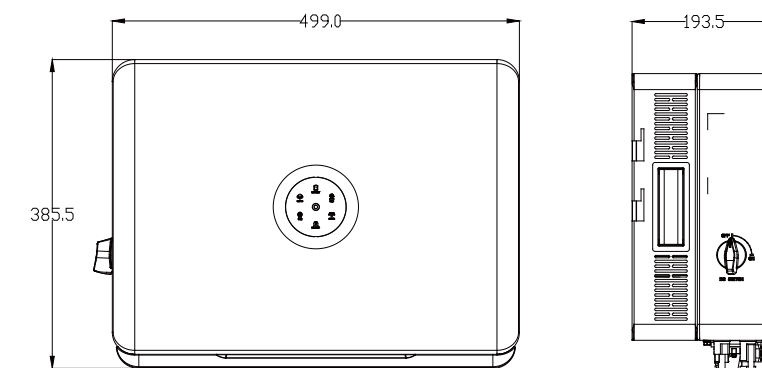

2.4 Datasheet

Type	H2-6K-S2-IE
PV String Input	
Max. PV Array Power [Wp]@STC	9000
Max. DC Voltage[V]	550
MPPT Voltage range [V]	90 - 500
Nominal DC Voltage[V]	360
Start Voltage/Min. Input Voltage[V]	100
Max. DC Input Current [A]	16/16
Max. Short Circuit Current [A]	19.2/19.2
Number of MPPT	2
No. of Strings per MPPT	1 / 1
Battery Input	
Rated Charging/Discharging Power [W]	6000
Battery Type	Lithium battery
Battery Voltage Range [V]	85 - 450
Max. Charging/Discharging Current [A]	30 / 30
AC Output (On-grid)	
Rated AC Power[W]	5500
Max. Apparent power[VA]*	5500
Rated AC Current [A]@230Vac	25.0
Max. AC Current Output to Utility Grid [A]	25.0
Max. AC Current from Utility Grid [A]	52.2
Current Inrush[A]	100
Max. AC Fault Current[A]	55
Max. AC Over Current Protection[A]	55
Nominal AC Voltage [V]	L/N/PE, 220, 230
Grid Frequency/Range [Hz]	50, 60
Total Harmonic Distortion[THDi]	< 3% (at nominal power)
Power Factor [cos φ]	0.8 leading~0.8 lagging
AC Output [Back-up Mode]	
Max. Output Power [VA]	5500
Rated Output Voltage [V]	230Vac, L/N/PE
Rated Output Frequency [Hz]	50/60

Type	H2-6K-S2-IE
Output THDv (@ Liner Load)	<3%
Peak Output Apparent Power [VA]	7200, 60s
Max.Output Current [A]	25.0
Efficiency	
Max. Efficiency	97.6%
Euro Efficiency	97.0%
Max.Battery Charging/Discharging Efficiency	96.6%
Protection	
AC Short-circuit Protection	Integrated
Overload Protection	Integrated
Residual Current Monitoring Unit	Integrated
Battery Input Reverse Polarity Protection	Integrated
Anti-islanding Protection	Integrated(AFD)
AC Surge Protection	Type II
DC Surge Protection	Type II
AFCI	Optional
Interface	
PV Input	MC4/H4
Battery	Quick Connector
AC Output	Plug-in connector
Display	LED+LCD+APP(Bluetooth)
Communication Port	CAN+RS485+DRM+CT+RS232
Communication	Wi-Fi/Ethernet/4G(Optional)/PLC(Optional)
General Data	
Topology	Non-isolated
Operating Temperature Range	-25°C to +60°C
Cooling Method	Natural Convection
Ambient Humidity	0% ~ 100% Non-condensing
Altitude	4000m(>3000m power derating)
Noise [dBA]	<25
Ingress Protection	IP65
Mounting	Rear Panel
Dimensions[H*W*D] [mm]	499.0*385.5*193.5mm
Weight [kg]	17.6
Standard Warranty [Year]	Refer to the warranty card
Applicable Standard	CEI 0-21, VDE4105-AR-N, VDE0126-1-1, EN50438, G98, G99, EN50549, AS4777.2, IEC62109-1&-2, EN61000-6-1/2/3/4

3.

INSTALLATION

notes



3.1 The Determination of the Installation Position

3.1.1 Mounting position

 DANGER
<ul style="list-style-type: none"> • Dangerous to life due to potential fire or electricity shock. • Do not install the inverter near any inflammable or explosive items.

 NOTICE
<ul style="list-style-type: none"> • This equipment meets the pollution degree II. • Inappropriate or the harmonized installation environment may jeopardize the life span of the inverter. • Installation directly exposed under intensive sunlight is not recommended. • The installation site must be well ventilated.

- The equipment employs natural convection cooling, and it can be installed indoor or outdoor.
- (1) Do not expose the inverter to direct solar irradiation as this could cause power derating due to overheating.
 - (2) Mount vertically or tilted backwards by max. 15 ° . Never install the inverter tilted forwards, sideways, horizontally or upside down.
 - (3) Install the inverter at eye level for convenience when checking the display and possible maintenance activities.

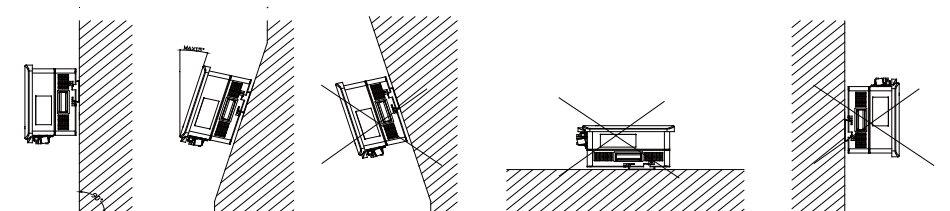

Figure 3.1
Mounting Method

(4) When mounting the inverter, please consider the solidness of wall for inverter, including accessories. Please ensure the Rear Panel mount tightly.
 To make sure the installation spot is suitably ventilated, if multiple SAJ hybrid solar inverters are installed same area.

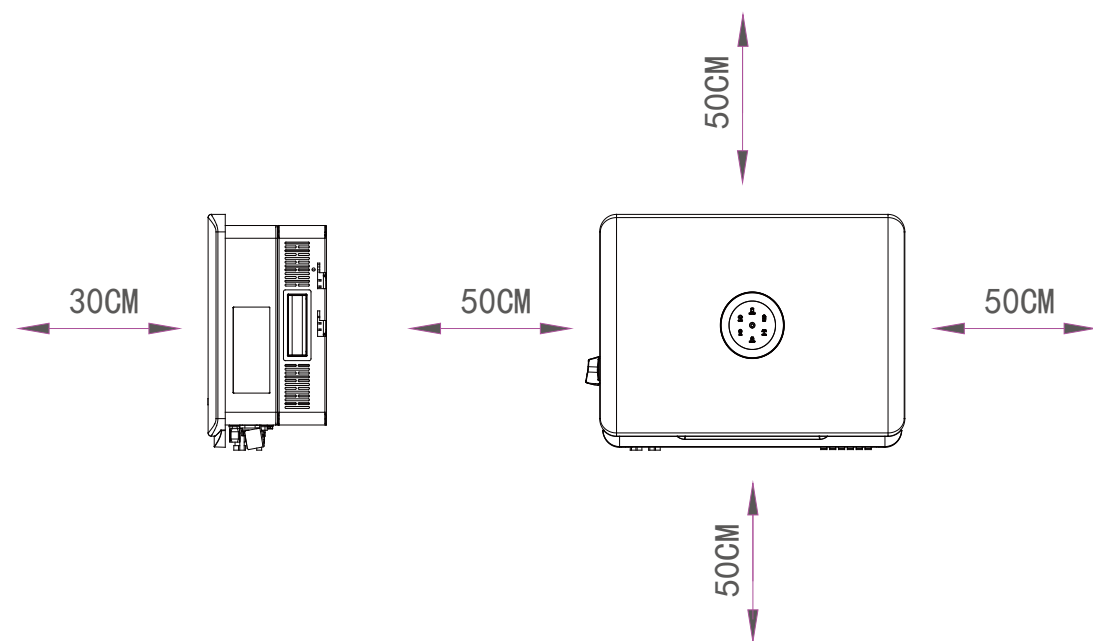

Figure 3.2
Minimum Clearance

Installation Environment Requirements

- The installation environment must be free of inflammable or explosive materials.
- Install the device away from heat source.
- Do not install the device at a place where the temperature changes extremely.
- Keep the device away from children.
- Do not install the device at daily working or living areas, including but not limited to the following areas: bedroom, lounge, living room, study, toilet, bathroom, theater and attic.
- When installing the device at the garage, please keep it away from drive way.
- Keep the device from water sources such as taps, sewer pipes and sprinklers to prevent water seepage.
- The product is to be installed in a high traffic area where the fault is likely to be seen.

Note: When installing outdoors, the height of the device from the ground should be considered to prevent the device from soaking in water. The specific height is determined by the site environment.

3.2 Mounting Procedure

Figure 3.3 Dimensions of rear panel of H2 inverter

1. Mark the Positions of the Drill Holes of the Rear Panel
 The mounting position should be marked as shown in Figure 3.3.

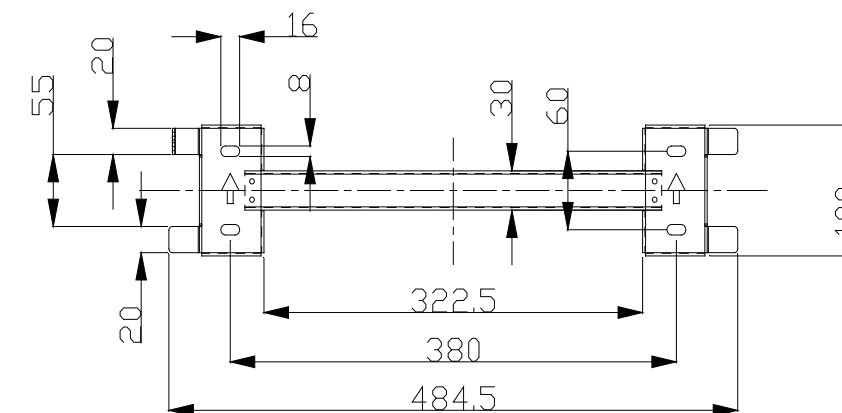

2. Drill Holes and Place the Expansion Tubes

Drill 4 holes in the wall (in conformity with position marked in Figure 3.4, and then place expansion tubes in the holes using a rubber mallet.

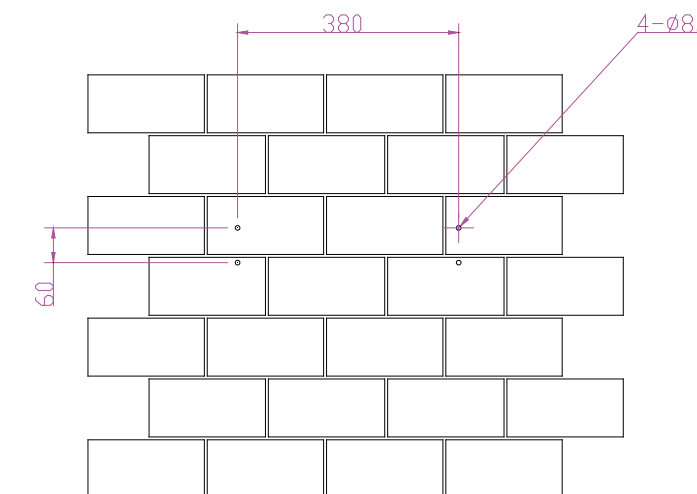

Figure 3.4
Drill holes dimensions of H2 inverter

3. Secure the Screws and the Rear Panel

The panels should be secured onto the mounting position by screws as shown in Figure 3.5.

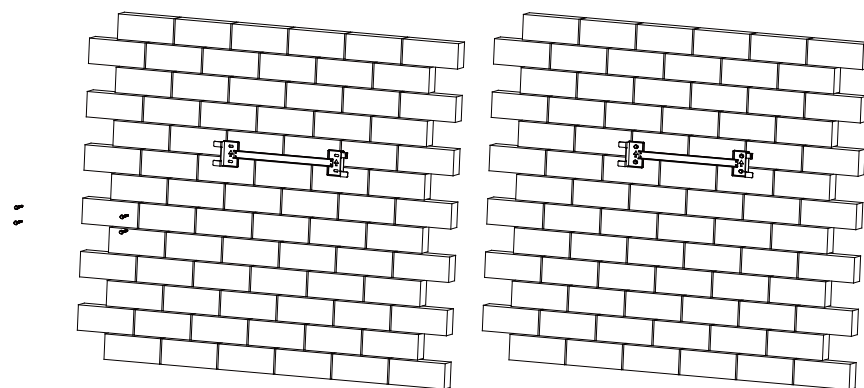

Figure 3.5
Mount the Rear Panel of H2 inverter

4. Mount the Inverter

Carefully mount the inverter into the rear panel as shown in Figure 3.6. Make sure that the rear part of the equipment is closely mounted into the rear panel.

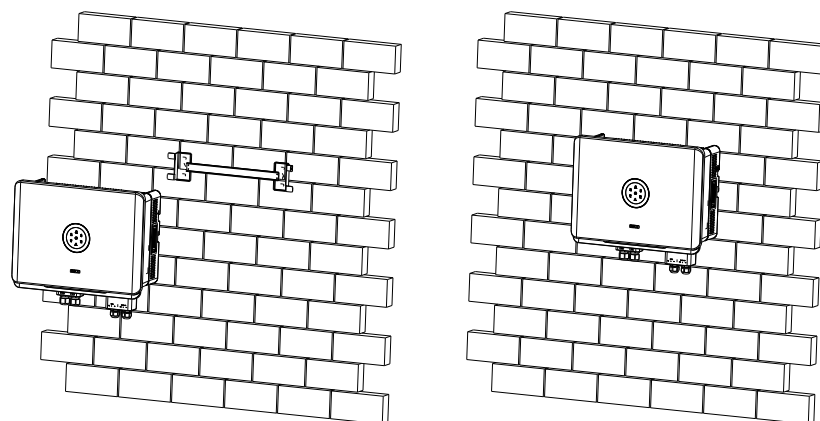
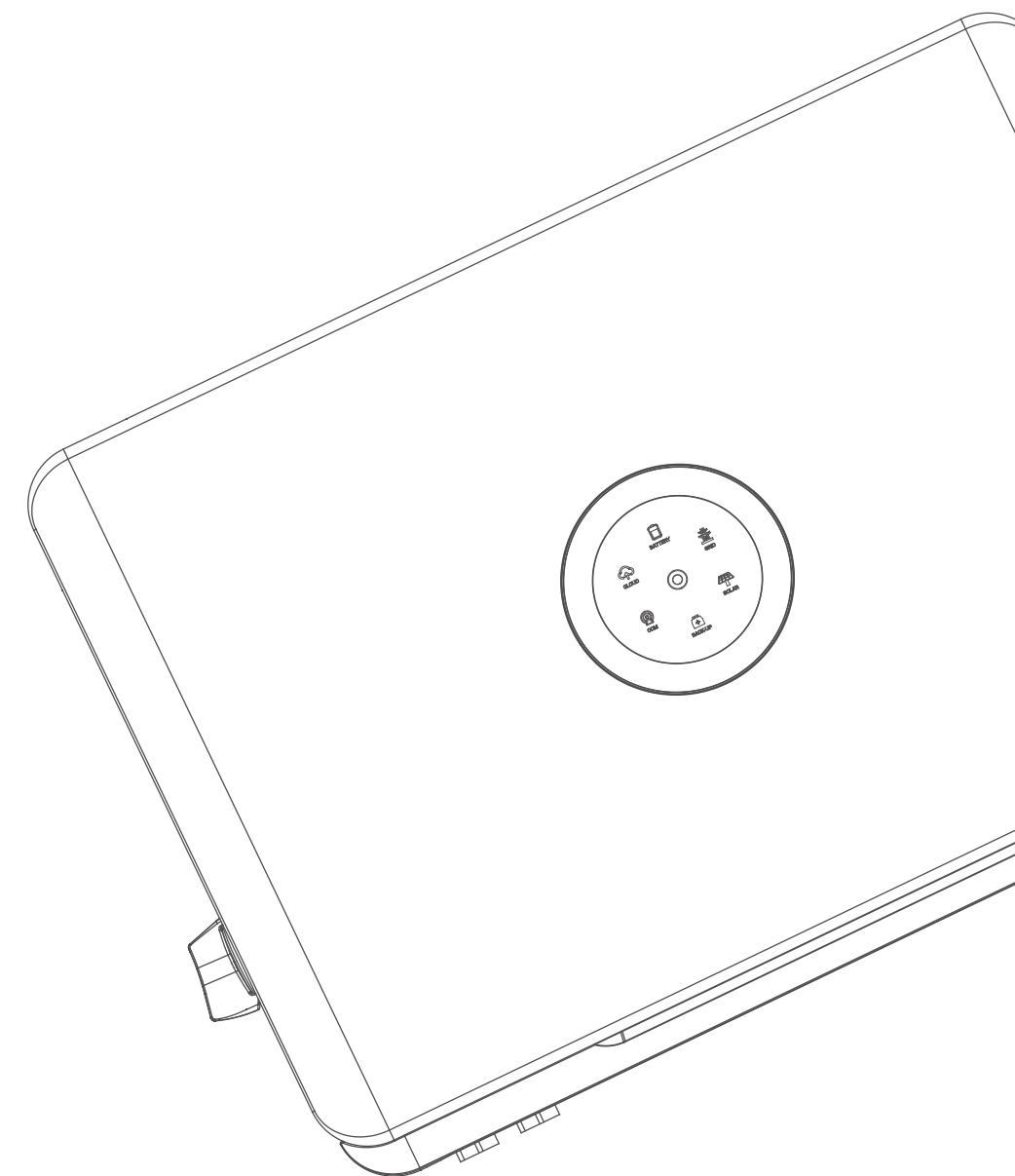

Figure 3.6
Mount H2 inverter



4.

ELECTRICAL connection



4.1 Safety Instruction for Hot-line Job

Electrical connection must only be operated on by professional technicians. Please keep in mind that the inverter is a bi-power supply equipment. Before connection, necessary protective equipment must be employed by technicians including insulating gloves, insulating shoes and safety helmet.

⚡ DANGER

- Dangerous to life due to potential fire or electricity shock.
- When power-on, the equipment should in conformity with national rules and regulations.
- The direct connection between the inverter and high voltage power systems must be operated by qualified technicians in accordance with local and national power grid standards and regulations.
- The PV arrays will produce lethal high voltage when exposed to sunlight.

⚠ WARNING

- Any improper operation during cable connection can cause device damage or personal injury

4.2 Specifications for Electrical Interface

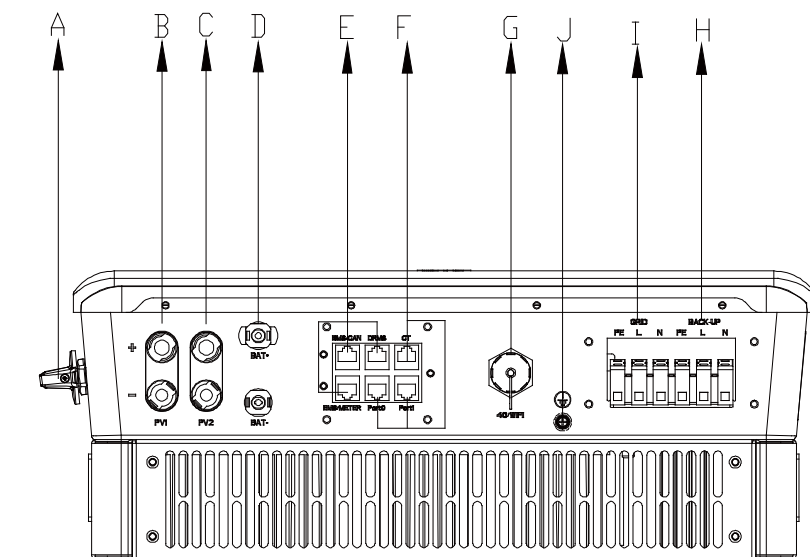

Figure 4.1 Electrical Interface of H2 inverter

Code	Name
A	DC Switch
B	DC Input
C	DC Input
D	Battery Input
E	BMS/ CAN/ EMS/ METER/ DRM
F	CT/ Inverter Parallel port
G	4G/ Wi-Fi
H	Backup
I	Grid
J	Ground Connection

Table 4.1
Specifications for Interface

4.3 Ground Connection

Remove the screw on the ground terminal and secure the cable with a screwdriver.

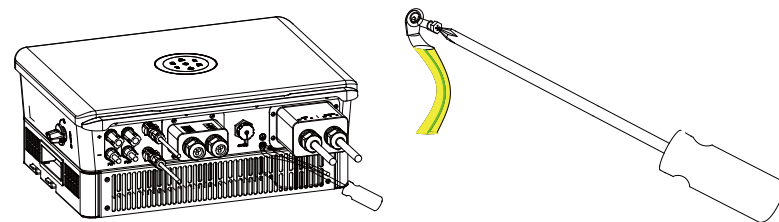

Figure 4.2
Inverter ground protection

4.4 AC Grid Wire and Backup Output Connection

Table 4.2
Recommended
Specifications of AC Cables

Cable Cross-sectional area (mm ²)		External diameter (mm)	
Range	Recommend	Range	Recommend
8~14	8	8~14	14
Additional grounding cable cross-sectional area (mm ²): 8			

If the grid-connection distance is too far, please amplify diameter selection of the AC cable as per the actual condition.

Procedure:

1.Open the waterproof cover, feed the AC cable through the AC waterproof hole.

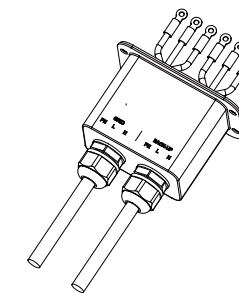

Figure 4.3
Thread the cables

2.Fix the cables according to conductor marks of L, N and PE.

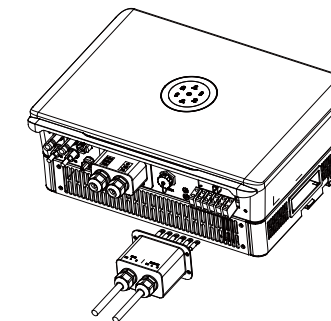

Figure 4.4
Connect the Cables

3. Secure all parts of the grid and backup connector tightly.

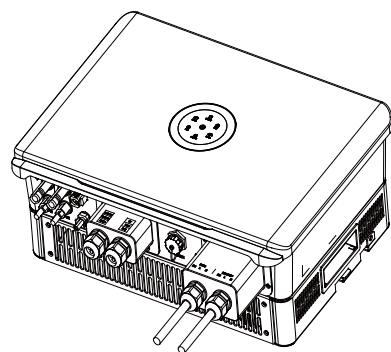
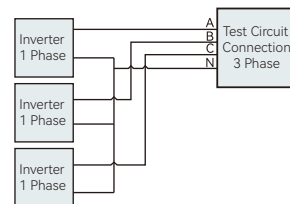

Figure 4.5
Screw the Connector

4. During off grid operation time, PE line at the BACK-UP end will remain to be connected with the PE line at the power grid end inside the inverter. (Only applicable to market in Australia)



The inverter should not be installed in multiple phase combinations. If any such multiple inverter combination is not tested, it should not be used or external devices should be used in accordance with the requirements of AS/NZS 4777.1.

Cable Cross-sectional area (mm ²)		External diameter (mm)	
Range	Recommend	Range	Recommend
4.0~6.0	4.0	4.2~5.3	5.3

Table 4.3
Recommended
Specifications of DC Cables

4.4.1 Multiple Inverter Combinations

4.5 PV Connection

Figure 4.7
Positive and negative connectors

DC connector is made up of the positive connector and the negative connector

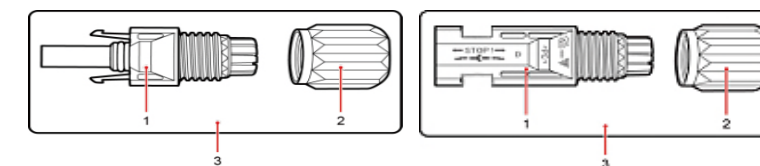

1. Insulated Enclosure 2. Lock Screw 3. Positive/ Negative Connector

NOTICE

Please place the connector separately after unpacking in order to avoid confusion for connection of cables.

Please connect the positive connector to the positive side of the solar panels, and connect the negative connector to the negative side of the solar side. Be sure to connect them in right position.

Connecting Procedures:

1. Use specified strip tool to strip the insulated enclosure of the positive and negative cables with appropriate length (8-10mm).

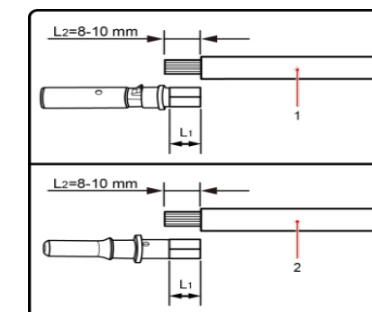

1. Positive Cable 2. Negative Cable

Figure 4.8
Connecting Cables

2. Feed the positive and negative cables into corresponding lock screws and crimp them tightly with a wire crimper. Make sure that the withdrawal force of the pressed cable is larger than 400N.
3. Plug in the pressed positive and negative cables into relevant insulated enclosure, a "click" sound should be heard when the contact cable assembly is seated correctly.
4. Fasten the lock screws on positive and negative connectors into corresponding insulated enclosure and make them tight.
5. Connect the positive and negative connectors into positive and negative DC input terminals of the inverter, a "click" sound should be heard when the contact cable assembly is seated correctly.

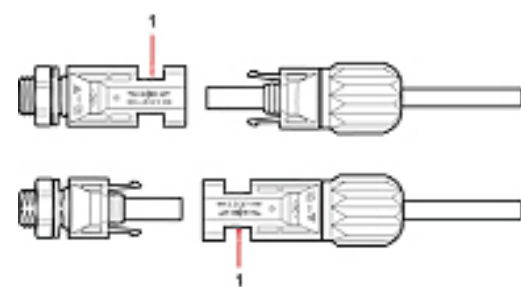

1. Connection Port

Figure 4.9
Connect to the Inverter

 **NOTICE**

Before insert the connector into DC input terminal of the inverter, please make sure that the DC switch of the inverter is OFF.
Please use the original H4 terminal to install.

4.6 Battery Connection

Table 4.4
Recommended
Specifications of DC Cables

Cable Cross-sectional area (mm ²)		External diameter (mm)	
Range	Recommend	Range	Recommend
4~6	5	4~6	5

If lithium battery is connected, it is not required to install a breaker between battery and inverter.

Procedure:

1. Open the waterproof cover, then feed the battery cable through the AC waterproof hole.

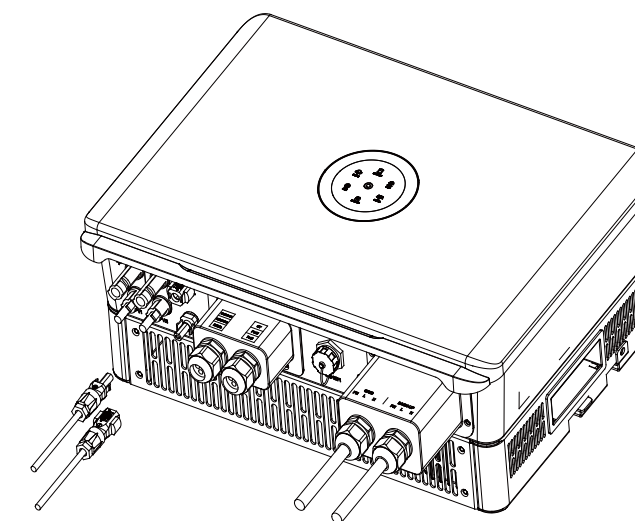

Figure 4.10
Open the waterproof cover

2. • Strip off the insulation skin of DC cable, the core is exposed to 15mm,
 - Open the spring using a 3mm wide bladed screwdriver
 - Carefully insert the stripped wire all the way in
 - The wire ends have to be visible in the spring
 - Close the spring. Make sure that the spring is snapped in
 - Insert the cable into the sleeve
 - Tighten the cable gland

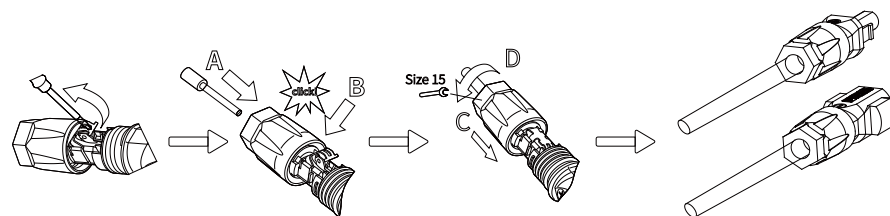

Figure 4.11
Battery Terminal

3. Fix the battery cable on the battery copper terminal by positive and negative in order.

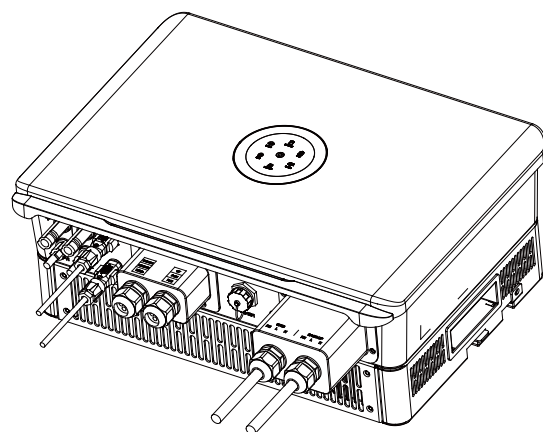

Figure 4.12
Connect the Battery Cable

Note: Battery temperature can be detected by temperature sensor that integrated in the battery module, and the temperature data can be reviewed on eSAJ App.

4.7 Earth Fault Alarm

This inverter complies with IEC 62109-2 clause 13.9 for earth fault alarm monitoring. If an Earth Fault Alarm occurs, the second LED indicator will be lit up until the error being solved and inverter functioning properly.
Note: The inverter cannot be used with functionally earthed PV Arrays.

4.8 Communication Connection

H2 series hybrid inverter has a RS232 communication port integrated.

4.8.1 Serial Port Definition

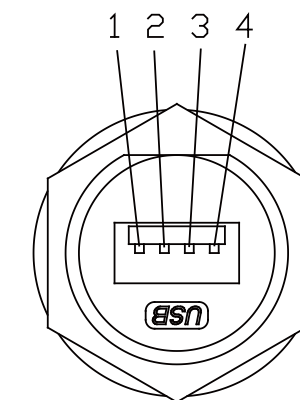

Figure 4.13
9-Pin serial port

Pin Number	Description	Effect
1	+7V	Power supply
2	RS-232 TX	Send data
3	RS-232 RX	Receive data
4	GND	Ground wire

Table 4.5 9-Pin
serial port introduction

USB interface with Wi-Fi module, please reference Wi-Fi user manual.

4.8.2 RJ45 Pin Port Definition



Figure 4.14
9-Pin serial port

EMS/METER		
1	RS485-A+	
2	RS485-B-	
3	NC	
4	NC	
5	NC	
6	NC	
7	RS485-A+	
8	RS485-B-	

CT		
1	R/CT.1+	
2	R/CT.1-	
3	NC	
4	NC	
5	NC	
6	NC	
7	NC	
8	NC	

DRM		
1	DRM 1/5	
2	DRM 2/6	
3	DRM 3/7	
4	DRM 4/8	
5	RefGen	
6	Com/DRM 0	
7	V+	
8	V-	

CAN/BMS		
1	NC	
2	NC	
3	NC	
4	CANH	
5	CANL	
6	NC	
7	NC	
8	NC	

PORT0		
1	NC	
2	NC	
3	NC	
4	NC	
5	NC	
6	NC	
7	NC	
8	NC	

PORT1		
1	NC	
2	NC	
3	NC	
4	NC	
5	NC	
6	NC	
7	NC	
8	NC	

4.8.3

Insert the communication cable

Open the waterproof cover, pass the crimped communication cable through waterproof cover, insert cable to the corresponding communication port, then tighten waterproof cover with screws.

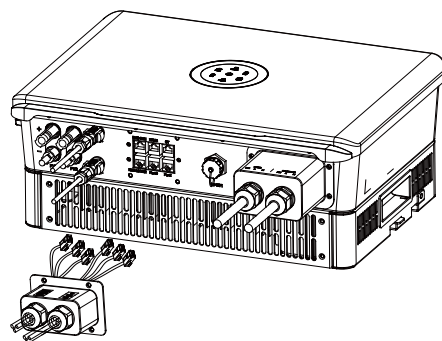

Figure 4.15
Connection of communication cable

4.8.4

Smart Meter Connection

Note: The hybrid inverter is with export limitation function, which can be realized by connecting SAJ recommended smart meter to the hybrid energy storage system. Users can contact SAJ for further details for the smart meters. If users have no intention to set the export limitation function, please ignore chapter 4.8.4.

If users have purchased the smart meter that recommended by SAJ, before setting the export limitation function, users shall connect the meter to the system as below:

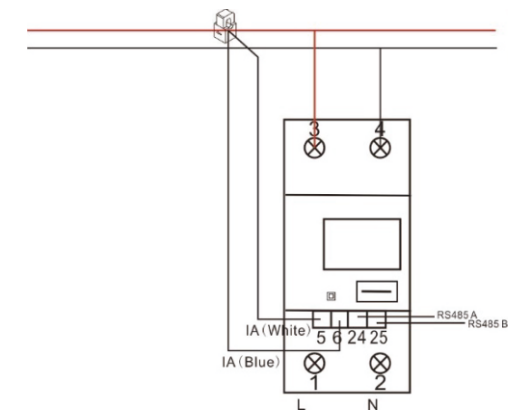

Figure 4.16
Smart meter wiring

4.9

System Connection

The system connection in Australia and New Zealand is as below, the neutral cable of AC and backup side must be connected together for the safety reason.

Note: DO NOT connect the PE terminal of BACKUP side.

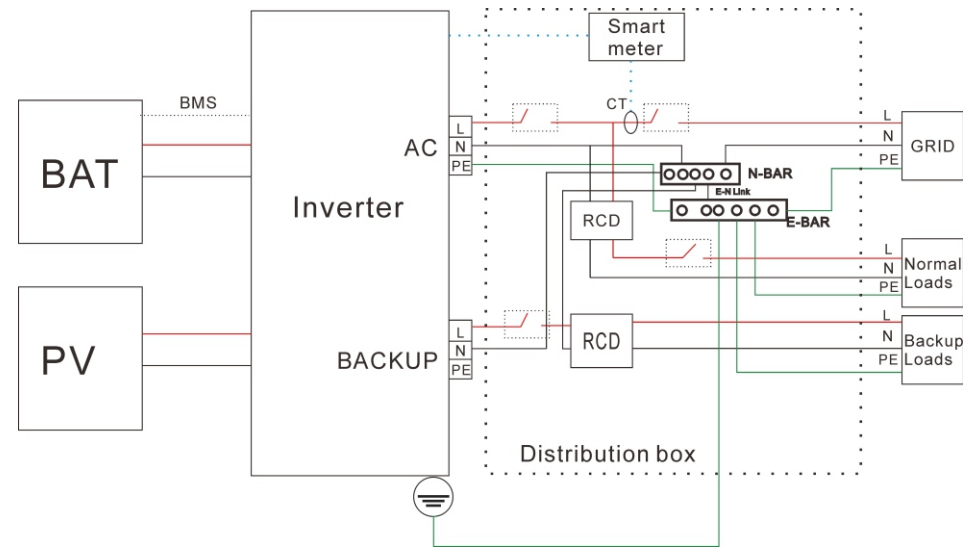

The system connection for grid system without special requirements is as below.
 Note: The backup PE line and earthing bar must be grounded properly. Otherwise, backup function may be inactive during blackout.

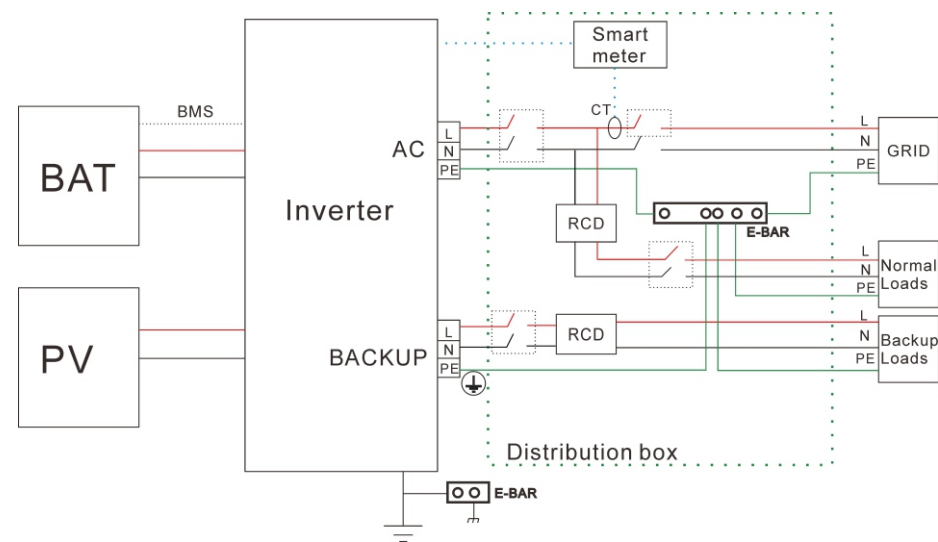

4.10 Connection Diagram

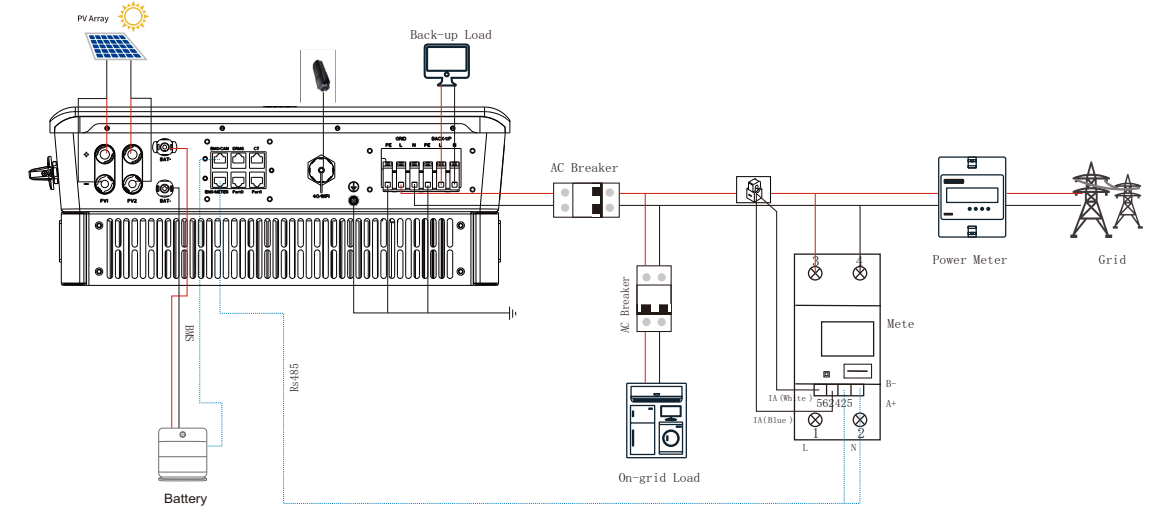

Figure 4.17
 H2 Connection diagram

4.11 External AC Circuit Breaker and Residual Current Device

Please install a circuit breaker to ensure the inverter is able to disconnect from grid safely. The inverter is integrated with a RCMU, however, an external RCD is needed to protect the system from tripping, either type A or type B RCD are compatible with the inverter. The integrated leakage current detector of inverter is able to detect the real time external current leakage. When a leakage current detected exceeds the limitation, the inverter will be disconnected from grid quickly, if an external residual current device is connected, the action current should be 30mA or higher.

Caution: For safety operation and regulation compliance, it is requested to install a breaker (63A) between grid and inverter.

5.

DEBUGGING



5.1 Start Up and Shut Down Inverter

5.1.1 Start Up

- (1) Connect the AC circuit breaker
- (2) Connect the DC circuit breaker between inverter and battery (if applicable)
- (3) Turn ON the battery (if applicable)
- (4) Turn ON the DC switch on the inverter
- (5) Install the communication module into the inverter
- (6) Setup the initial setting for inverter on eSAJ Home
- (7) Observe the LED indicators on the inverter to ensure the inverter is running properly

5.1.2 Shut Down

Automatically shut down, when the solar light intensity is not strong enough during sunrise and sunset or the output voltage of photovoltaic system is less than the minimum input power of inverter, inverter will shut down automatically.

Shut down manually, disconnect AC side circuit breaker first, if multiple inverters are connected, disconnect the minor circuit breaker prior to disconnection of main circuit breaker. Disconnect the DC switch after inverter has reported grid connection lost alarm.

5.2 Introduction of LED Indicator

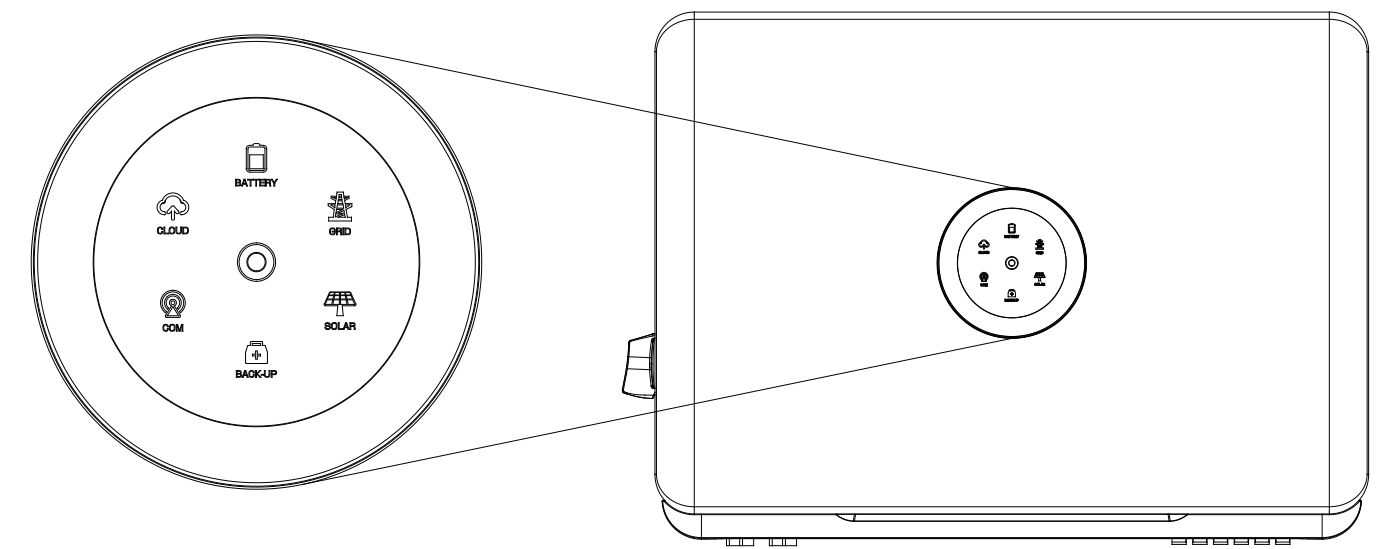

Figure 5.1
LED indicators

LED indicator	Status	Description
	LED off	Inverter power off
	Breathing	Inverter is at initial state or standby state
	Solid	Inverter running properly
	Breathing	Inverter is upgrading
	Solid	Inverter is faulty
	Solid	Importing electricity from grid
	On 1s, off 1s	Exporting electricity to grid
	On 1s, off 3s	Not importing and exporting at all
	Off	Off-grid
	Solid	Battery is discharging
	On 1s, off 1s	Battery is charging
	On 1s, off 3s	SOC low
	Off	Battery is disconnected or inactive
	Solid	Connected to grid
	On 1s, off 1s	Counting down to grid connection
	On 1s, off 3s	Grid is faulty
	Off	No grid
	Solid	PV array is running properly
	On 1s, off 1s	PV array is faulty
	Off	PV array is not operating
	Solid	AC side load is running properly
	On 1s, off 1s	AC side load overload
	Off	AC side is turned off
	Solid	Both BMS and meter communication are good
	On 1s, off 1s	Meter communication is good, BMS communication is lost
	On 1s, off 3s	Meter communication is lost, BMS communication is good
	Off	Both meter and BMS communication are lost
	Solid	Connected
	On 1s, off 1s	Connecting
	Off	Disconnected

5.3 Commissioning

Start up:

- (1) Connect the AC circuit breaker
- (2) Connect the DC circuit breaker between inverter and battery (if applicable)
- (3) Turn ON the battery (if applicable)
- (4) Turn ON the DC switch on the inverter
- (5) Install the communication module into the inverter
- (6) Setup the initial setting for inverter on eSAJ Home
- (7) Observe the LED indicators on the inverter to ensure the inverter is running properly

5.4 eSAJ APP Connection

5.4.1 Account Login

- Step 1** Log in to eSAJ Home, if you do not have an account, please register first.
- Step 2** Go to the "Tool" interface and select "Remote Configuration"
- Step 3** Click on "Bluetooth" and activate the Bluetooth function on your phone, then click on "Next"
- Step 4** Choose your inverter according to your inverter SN's tail numbers
- Step 5** Click on the inverter to enter inverter setting
- Step 6** Select the corresponding country and grid code for initial setting, please contact your local grid operator for which grid compliance to select

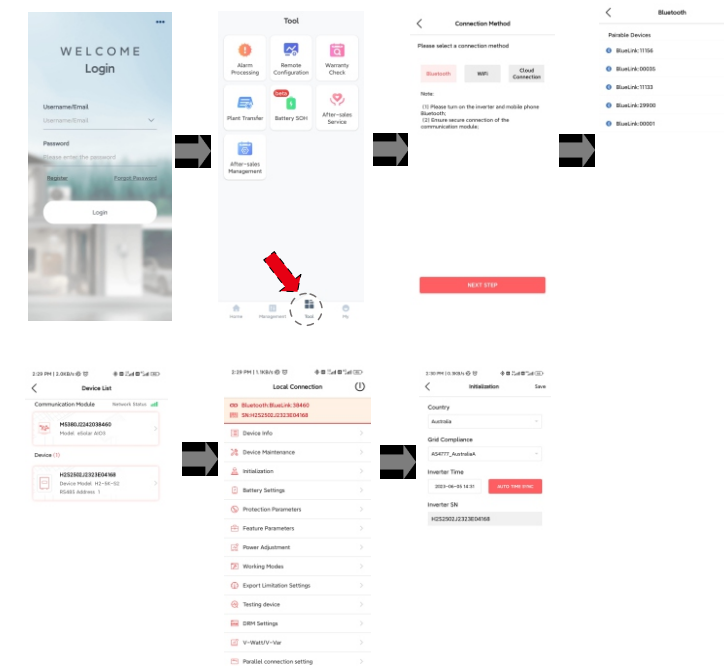

5.4.2 Local connection

- Step 1** Open eSAJ APP and click on the dot icon on the top right corner
- Step 2** Select "Local Connection"
- Step 3** Enter password "123456"
- Step 4** Click on "Bluetooth" and activate the Bluetooth function on your phone, then click on "Next"
- Step 5** Choose your inverter according to your inverter SN's tail numbers
- Step 6** Click on the inverter to enter inverter setting
- Step 7** Select the corresponding country and grid code for

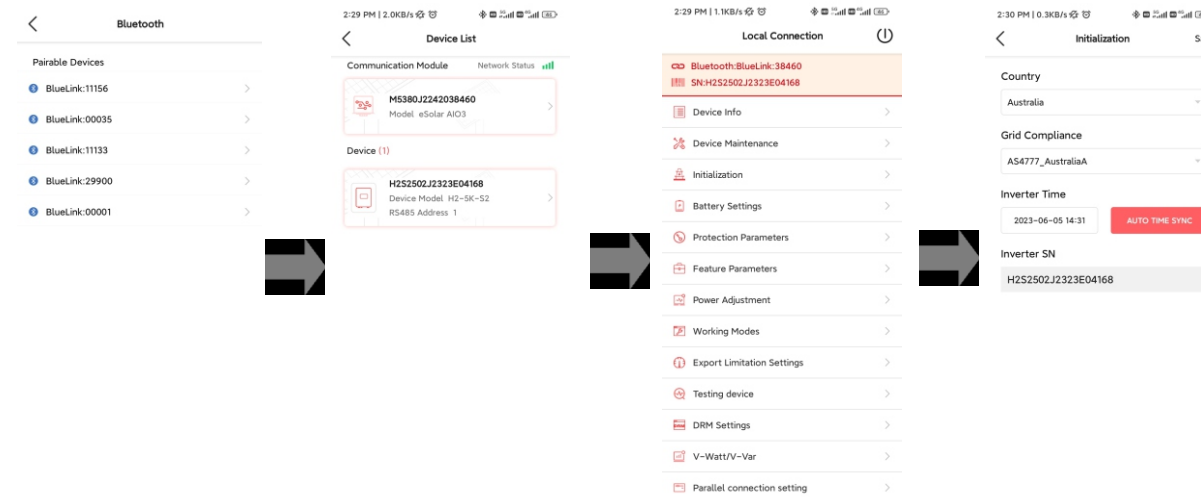
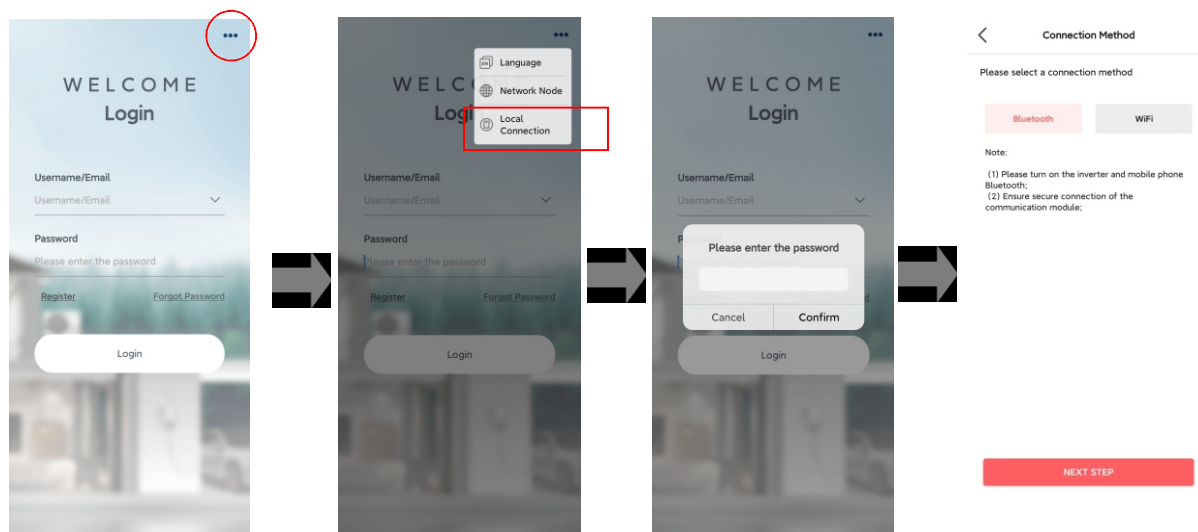

5.4.3 Inverter Setting Review

After commissioning, the device info including device basic info, running info and event info can be viewed. Country and grid code can be viewed from initial setting.

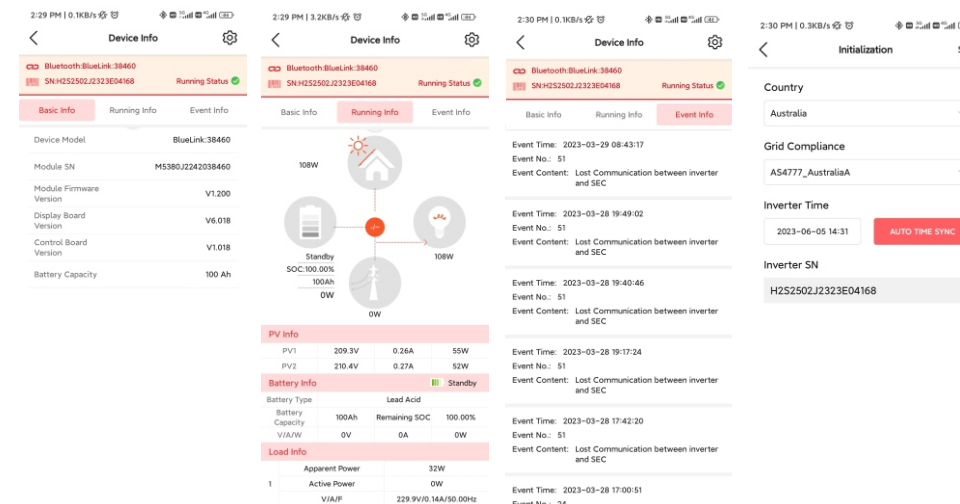

5.5 Working Modes

5.5.1 Selecting working modes procedures

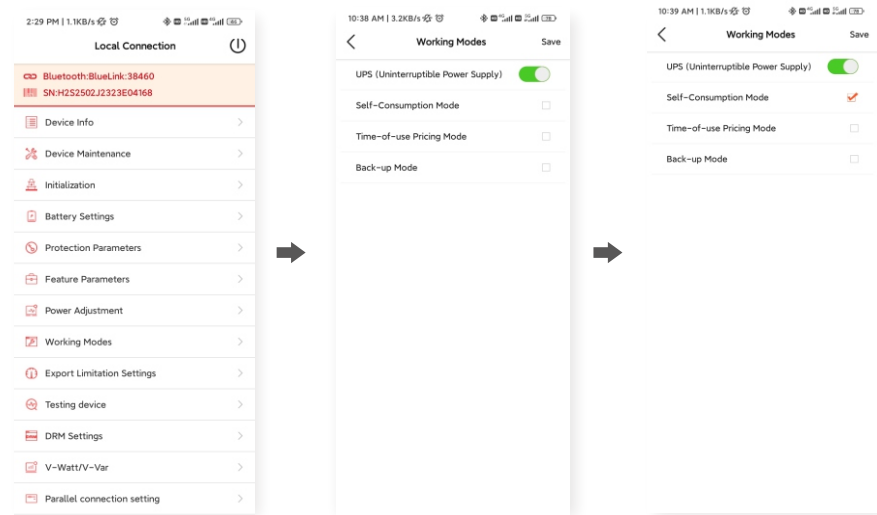

5.5.2 Working modes introduction

Self-consumption Mode: When the solar is sufficient, electricity generated by photovoltaic system will be supplied to load first, the surplus energy will be stored in battery, then the excess electricity will be exported to the grid. When the solar is sufficient, the battery will release electricity to supply load.

Back-up Mode: Reserved Backup SOC setting value can be adjusted, when battery SOC is less than reserved SOC value, battery can only be charged, until SOC reaches reserved value, the battery will be stopped charging; when SOC is larger than SOC setting value, battery will behave as Self-use mode.

Time-of-use Mode: Battery charging period and discharging period can be set, during charging period, battery can only be charged, while in discharging period, battery can only be discharged, the rest of the period, battery will behave as Self-use mode.

5.6 Export Limit Setting

Figure 5.2
Export limit wiring schematic

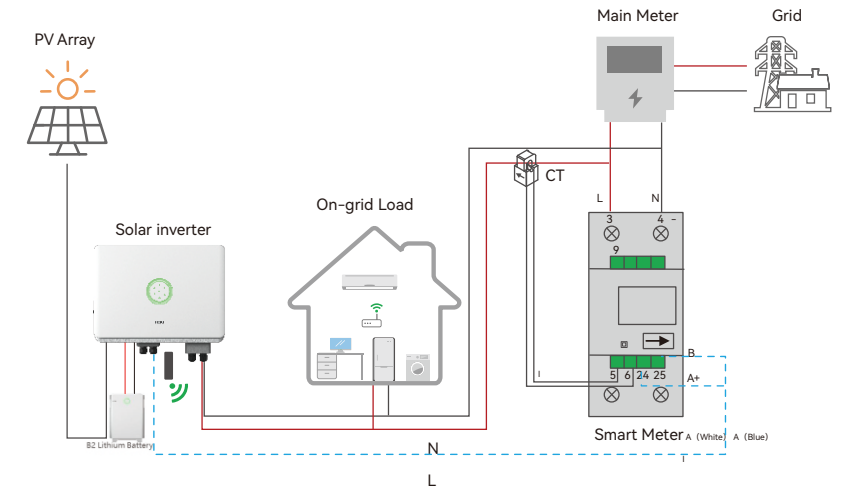

Enter the main page of local connection and click on Export limitation setting, enter the password "201561".

5.6.1 APP Setting

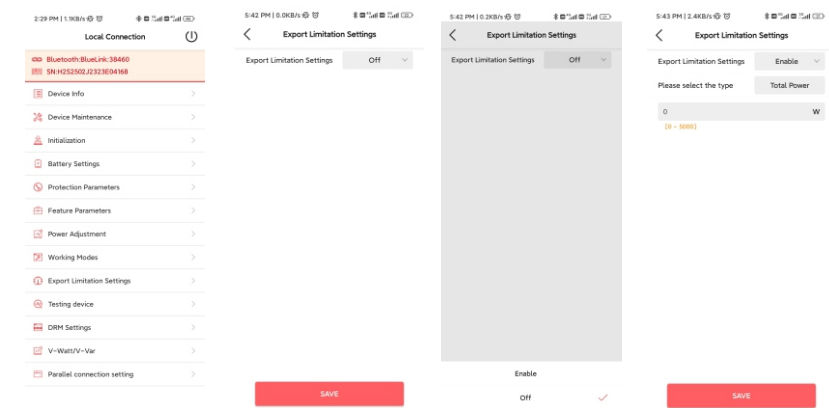

There are two methods to control the export limit, the two methods are alternative to each other.
 Method1: Export limitation setting is to control the export electricity to the grid.
 Method 2: Generation limit is to control the electricity generated by the inverter.

5.7 Self-test

(For Italy)

Italian Standard CEI0-21 requires a self-test function for all inverter that connected to utility grid. During the self-testing time, inverter will check the reaction time for over frequency, under frequency, overvoltage and undervoltage. This self-test is to ensure the inverter is able to disconnect from grid when required. If the self-test fails, the inverter will not able to feed into the grid.

The steps of running Self-test are as followed:

Step 1:

Connect a communication module (Wi-Fi/ 4G/ Ethernet) with inverter (connection procedure can refer to eSolar Module Quick Installation Manual)

Step 2:

Select Italy for Country and choose your corresponding Grid Code from Initial Setting.

- device maintenance**>
- Initial Setting**>
- InvWaveCheck Set**>
- Protection data**>
- Feature data**>
- Power adjustment**>
- Communication**>
- Export limitation setting**>
- Self-test**>

Step 3: Start Self-test

You can choose self-test item required. Individual self-test time is approx. 5 minutes. All self-test time is approx. 40 minutes. After the self-test is completed, you can save the test report. If self-test is failed, please contact with SAJ or your inverter supplier.

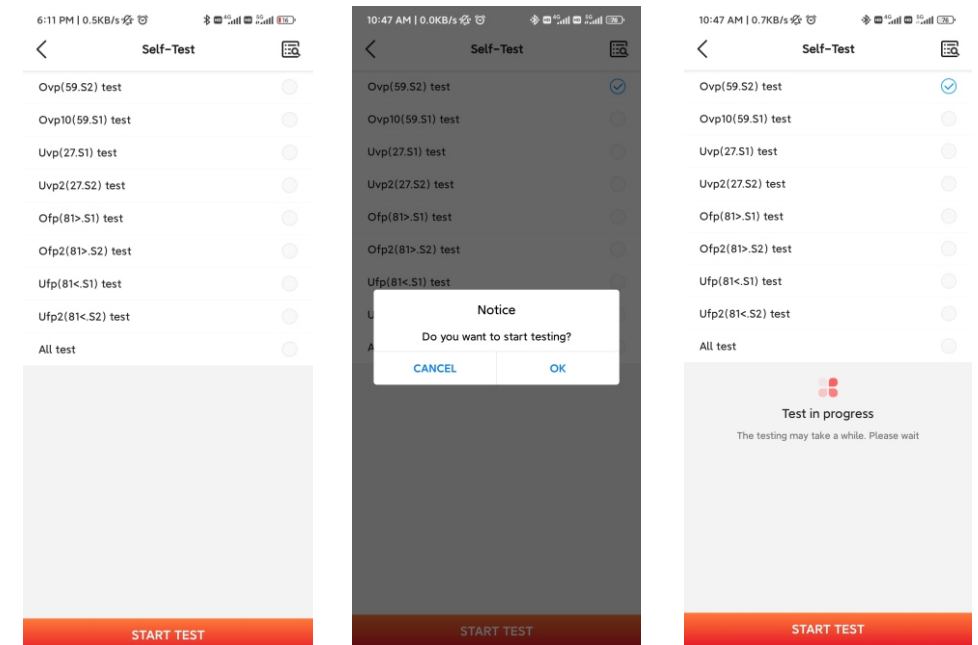

5.8 Setting Reactive Power Control (For Australia)

5.8.1 Setup Fixed Power Factor Mode & Fixed Reactive Power Mode

Fixed Power Factor Mode

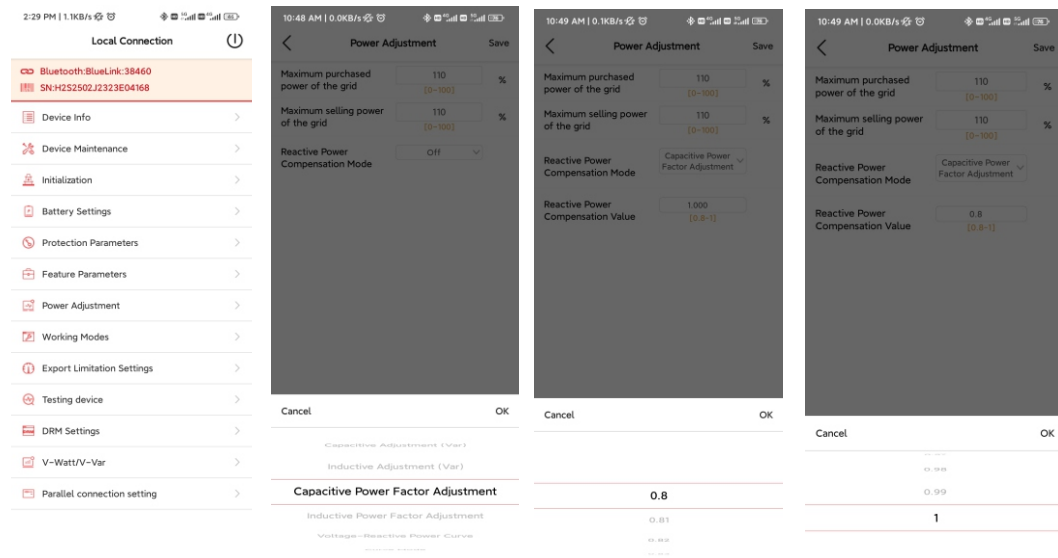

Step 1: Select Power Adjustment and enter password “201561”.

Step 2: Select Capacitive Power Factor or Inductive Power Factor according to your local grid regulation. The power factor range is from 0.8 leading ~ 0.8 lagging.

Fixed Reactive Power Mode

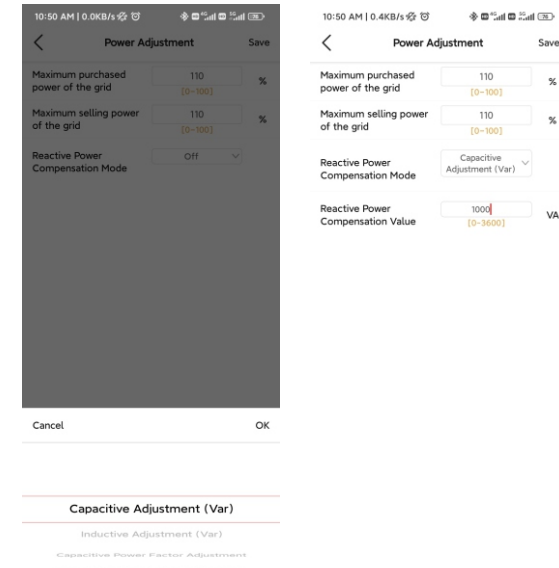

Step 1: Select Inductive Adjustment Var or Capacitive Var according to your local grid regulation. The power range is from $-60\%P_n \sim 60\%P_n$.

5.8.2 Setup V-Watt and Volt-Var mode

This inverter complies with AS/NZS 4777.2 2020 for power quality response modes. The inverter satisfies different regions of DNSPs' grid connection rules requirements for volt-watt and volt-var Settings. e.g.: AS4777 series setting as below Fig 6.2&6.3.

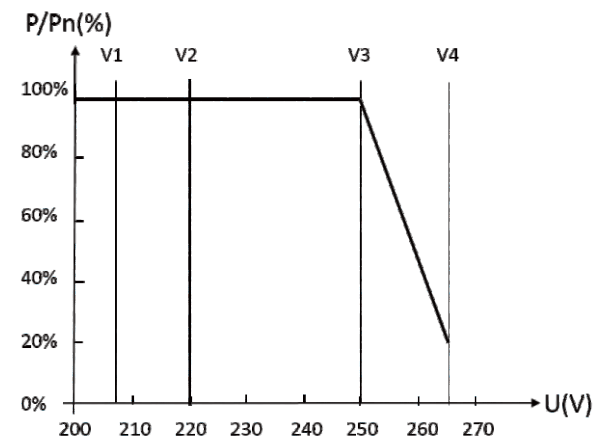

Figure 5.3
Curve for a Volt-Watt response mode (AS4777 Series)

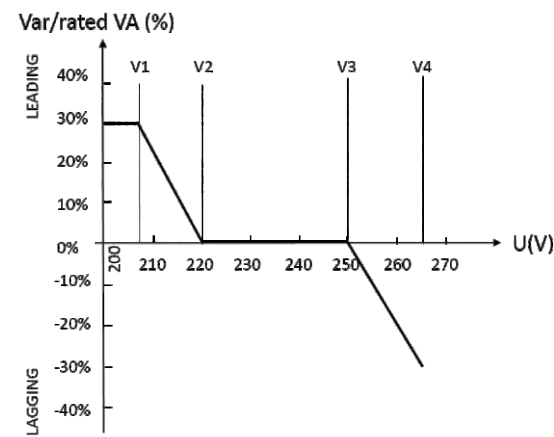
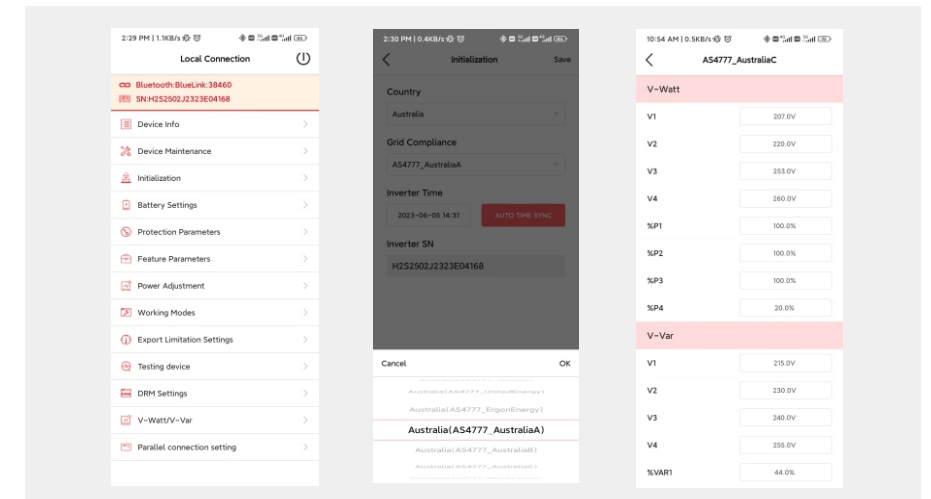

Figure 5.4
Curve for a Volt-Var control mode (AS4777 Series)

Setting procedure:

- AS4777 grid compliance has been set during production, please select corresponding grid compliance according to state regulation during installation. You can choose a state regulation compliance with your local grid via eSAJ Home.
- Log in to eSAJ Home, click “Local Connection”, for connection procedure please refer to chapter 5.3 for Nearby monitoring.
- Click “V-Watt/V-Var” to enter DNSPs settings, choose a suitable state regulation from the



Note:

- With regard to the Power rate limit mode, SAJ sets the product WGrA to 16.67%Pn by default in the following cases according to the requirements of 3.3.5.2 as 4777.2: 2020.
- Soft ramp up after connect,
 - Reconnect or soft ramp up/down following a response to frequency disturbance.

If the following fault code occurs, please contact professional personnel for treatment.

Code	Fault Information
1	Master Relay Error
2	Master EEPROM Error
3	Master Temperature High Error
4	Master Temperature Low Error
5	Lost Communication M<->S
6	GFCI Device Error
7	DCI Device Error
8	Current Sensor Error
9	Master Phase1 Voltage High
10	Master Phase1 Voltage Low
11	Master Phase2 Voltage High
12	Master Phase2 Voltage Low
13	Master Phase3 Voltage High
14	Master Phase3 Voltage Low
15	Grid Voltage 10Min High
16	OffGrid Output Voltage Low
17	OffGrid Output Short Circuit
18	Master Grid Frequency High
19	Master Grid Frequency Low
21	Phase1 DCV Error
22	Phase2 DCV Error
23	Phase3 DCV Error
24	Master No Grid Error
27	GFCI Error
28	Phase1 DCI High
29	Phase2 DCI High
30	Phase3 DCI High
31	ISO Error
32	Bus Voltage Balance Error
33	Master Bus Voltage High
34	Master Bus Voltage Low
35	Master Grid Phase Error
36	Master PV Voltage High Error
37	Master Islanding Error
38	Master HW Bus Voltage High
39	Master HW PV Current High
40	Master Self-Test Failed
41	Master HW Inv Current High
42	Master AC SPD Error
43	Master DC SPD Error
44	Master Grid NE Voltage Error

Code	Fault Information
45	Master Fan1 Error
46	Master Fan2 Error
47	Master Fan3 Error
48	Master Fan4 Error
49	Lost Communication between Master and Meter
50	Lost Communication between M<->S
51	Lost Communication between inverter and Grid Meter
52	HMI EEPROM Error
53	HMI RTC Error
54	BMS Device Error
55	BMS Lost.Conn
56	CT Device Err
57	AFCI Lost Com.Err
59	Lost Communication between inverter and PV Meter
61	Slave Phase1 Voltage High
62	Slave Phase1 Voltage Low
63	Slave Phase2 Voltage High
64	Slave Phase2 Voltage Low
65	Slave Phase3 Voltage High
66	Slave Phase3 Voltage Low
67	Slave Frequency High
68	Slave Frequency Low
73	Slave No Grid Error
74	Slave PV Input Mode Error
75	Slave HW PV Curr High
76	Slave PV Voltage High Error
77	Slave HW Bus Volt High
81	Lost Communication D<->C
83	Master Arc Device Error
84	Master PV Mode Error
85	Authority expires
86	DRM0 Error
87	Master Arc Error
88	Master SW PV Current High
89	Battery Voltage High
90	Battery Current High
91	Battery Charge Voltage High
92	Battery OverLoad
93	Battery SoftConnet TimeOut
94	Output OverLoad
95	Battery Open Circuit
96	Battery Discharge Voltage Low



Fault code



7.

Recycling and Disposal



This device should not be disposed as residential waste. An Inverter that has reached the end of its life and is not required to be returned to your dealer, it must be disposed carefully by an approved collection and recycling facility in your area.

8. Transportation

Take care of the product during transportation and storage, keep less than 7 cartons of inverter in one stack.

9. Contact SAJ

Guangzhou Sanjing Electric Co., Ltd.
SAJ Innovation Park, No.9, Lizhishan Road, Guangzhou Science City, Guangdong,
PR.China.
Postcode: 510663
Web: <http://www.saj-electric.com>

Technical Support & Service
Tel: +86 20 6660 8588
Fax: +86 206660 8589
E-mail: service@saj-electric.com

International Sales
Tel: 86-20-66608618/66608619/66608588/66600086
Fax: 020-66608589
E-mail: info@saj-electric.com

Domestic Sales
Tel: 020-66600058/66608588
Fax: 020-66608589