



GUANGZHOU SANJING ELECTRIC CO.,LTD



Tel: (86)20 66608588 Fax: (86)20 66608589 Web: www.saj-electric.com

Add: SAJ Innovation Park, No.9, Lizhishan Road, Science City, Guangzhou High-tech Zone, Guangdong, P.R.China

V1.1

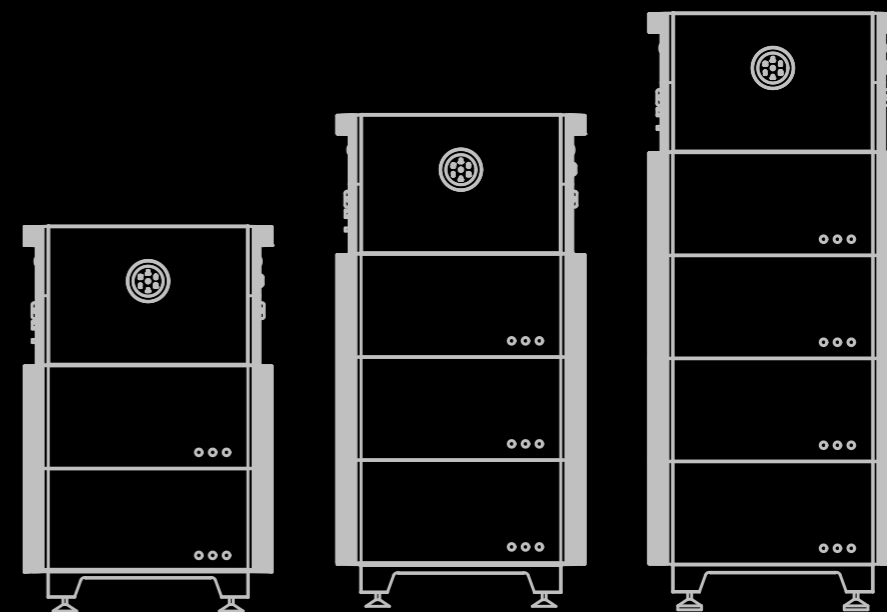

HS2/AS2 Series

**THREE PHASE ALL-IN-ONE ENERGY STORAGE SYSTEM
USER MANUAL**

HS2-5~10K-T2-X

AS2-5~10K-T-X

Preface

Thank you for choosing SAJ product. We are pleased to provide you first-class products and exceptional service.

This manual includes information for installation, operation, maintenance, trouble shooting and safety. Please follow the instructions of this manual so that we can ensure delivery of our professional guidance and wholehearted service.

Customer-orientation is our forever commitment. We hope this document proves to be of great assistance in your journey for a cleaner, greener world.

Please check for the latest version at www.saj-electric.com

Guangzhou Sanjing Electric Co., Ltd.

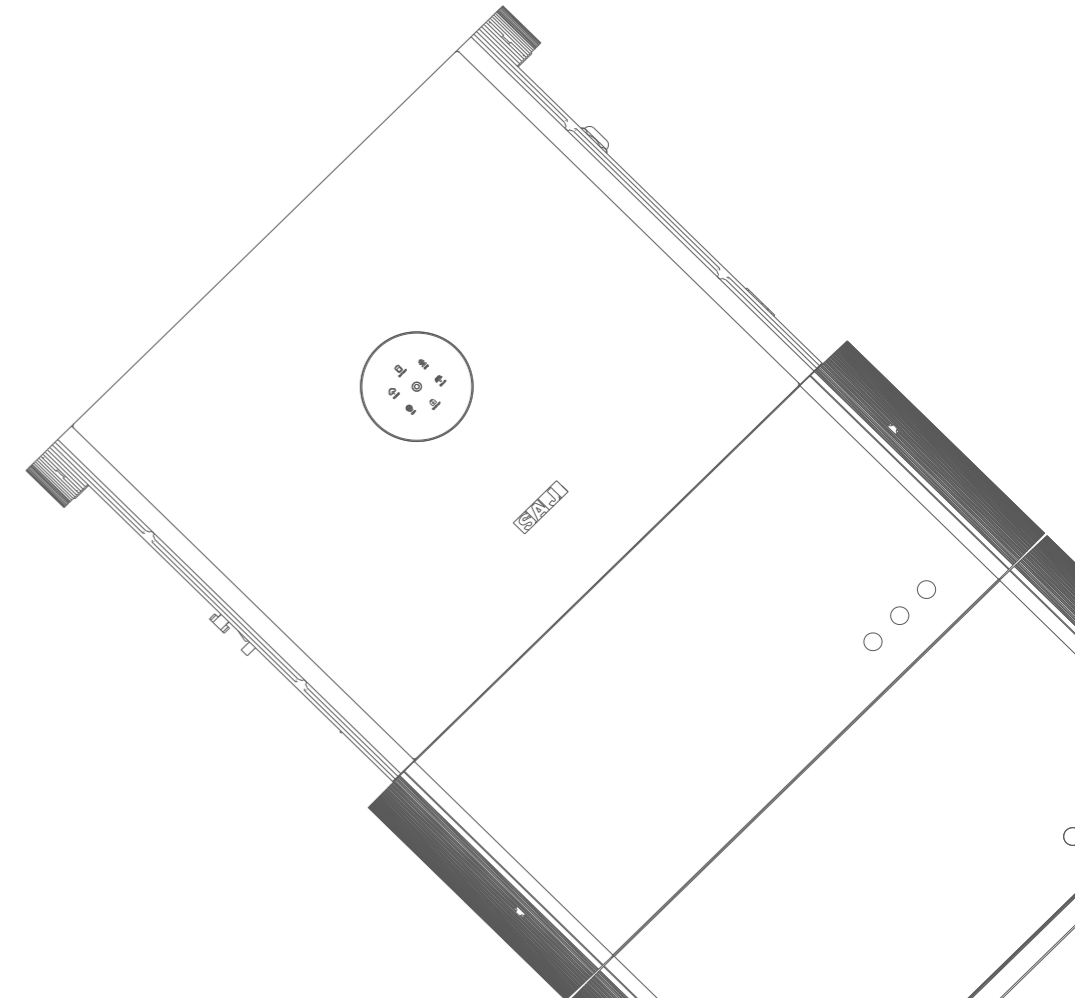

TABLE OF CONTENTS

1. SAFETY PRECAUTIONS	1
1.1 Scope of Application	2
1.2 Safety Instructions	2
1.3 Target Group	2
2. PREPARATION	3
2.1 Safety Instructions	4
2.2 Explanations Of Symbols	5
2.3 Battery Handling	6
2.4 Emergency Situation	6
3. PRODUCT INFORMATION	9
3.1 Application Scope of Products	10
3.2 Specification for Product Model	10
3.3 Overview of Productsl.....	10
3.4 Terminals Description	11
3.5 Datasheet	14
4. INSTRUCTIONS FOR INSTALLATION.....	17
4.1 Unpacking and Inspection	18

4.1.1 Checking the Package.....	18
4.1.2 Scope of Delivery	18
4.2 Installation and Position	20
4.2.1 Installation Position and Clearance	20
4.2.2 Mounting Method	21
4.3 Mounting Procedure.....	22
4.3.1 Installation Tools.....	22
4.3.2 Mounting Procedure.....	23
5. ELECTRICAL CONNECTION	33
5.1 Additional Grounding Cable	34
5.2 Connecting Battery COMM Cable.....	36
5.2.1 Earth Fault Alarm	37
5.2.2 External AC Circuit Breaker and Residual Current Device	38
5.3 PV Side Connection.....	38
5.4 Communication Connection	42
5.5 Connection Battery COMM Cable.....	45
5.6 Connecting Battery Power Cable.....	46
5.7 System Connection	47
5.8 System Connection Diagram.....	51
5.9 Installation of Side Covers of Battery Unit	52
5.10 AFCI (Optional)	52
6. COMMISSIONING.....	53
6.1 Start Up and Shut Down the Energy Storage System	54
6.1.1 Start Up.....	54
6.1.2 Shut Down.....	54
6.2 Introduction of Human-computer Interface	55
6.3 Commissioning	57
6.4 eSAJ APP Connection.....	57

- 6.4.1 Account Login..... 57
- 6.4.2 Local Connection 59
- 6.4.3 Inverter Setting Review..... 61
- 6.5 Working Modes 62
 - 6.5.1 Selecting Working Modes Procedures..... 62
 - 6.5.2 Working Modes Instruction..... 62
- 6.6 Export Limit Setting 63
 - 6.6.1 APP Setting..... 64
- 6.7 Self-test (For Italy)..... 65
- 6.8 Setting Reactive Power Control (For Australia)..... 67
 - 6.8.1 Setup Fixed Power Factor Mode 67
 - 6.8.2 Setup V-Watt and Volt-Var Mode..... 69
- 7. MAINTENANCE71**
 - 7.1 Transportation..... 72
 - 7.2 Storage 72
- 8. TROUBLESHOOTING and WARRANTY73**



1.1 Scope of Application

This User Manual describes instructions and detailed procedures for installing, operating, maintaining, and troubleshooting of the following SAJ products:

HS2-5K-T2-X; HS2-6K-T2-X; HS2-8K-T2-X; HS2-10K-T2-X; HS2-10K-T2-B-X

AS2-5K-T-X; AS2-6K-T-X; AS2-8K-T-X; AS2-10K-T-X; AS2-10K-T-B-X

1.2 Safety Instructions



DANGER

· DANGER indicates a hazardous situation which, if not avoided, will result in death or serious injury.



WARNING

· WARNING indicates a hazardous situation which, if not avoided, can result in death or serious injury or moderate injury.



CAUTION

· CAUTION indicates a hazardous condition which, if not avoided, can result in minor or moderate injury.



NOTICE

· NOTICE indicates a situation that can result in potential damage, if not avoided.

1.3 Target Group

Only qualified electricians who have read and fully understood all safety regulations contained in this manual can install, maintain and repair the device. Operators must be aware of the high-voltage device.

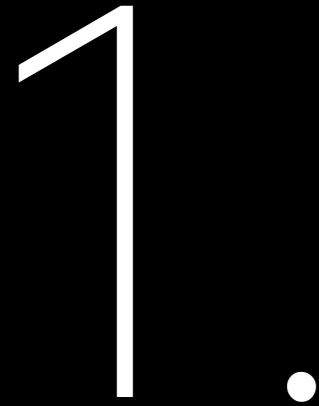

SAFETY PRECAUTIONS



2.

PREPARATION



2.1 Safety Instructions

For safety, be sure to read all the safety instructions carefully prior to any works, and please observe the appropriate rules and regulations of the country or region where you installed all-in-one energy storage system.

 DANGER

- There is possibility of dying due to electrical shock and high voltage.
- Do not touch the operating component of the inverter; it might result in burning or death.
- To prevent risk of electric shock during installation and maintenance, please make sure that all AC and DC terminals are plugged out.
- Do not touch the surface of the equipment while the housing is wet, otherwise, it might cause electrical shock.
- Do not stay close to the equipment while there are severe weather conditions including storm, lightning, etc.
- Before opening the housing, the SAJ inverter must be disconnected from the grid and PV generator; you must wait for at least five minutes to let the energy storage capacitors completely discharged after disconnecting from power source.
- Please keep the power off prior to any operations
- Do not expose the battery to temperatures in excess of 50°C.
- Do not subject the battery to any strong force.
- Keep inflammable and explosive dangerous items or flames away from the battery.
- Do not soak the battery in water or expose it to moisture or liquids.
- Do not use the battery in areas where the ammonia content of the air exceeds 20ppm.

 WARNING







- Only qualified personnel who has full knowledge of local safety regulations and local standards on battery can install, maintain, retrieve and process this product.
- SAJ electric shall not be liable for any loss or warranty claims arising from any unauthorized change of product which may cause fatal injury to the operator, third party or equipment performance.
- For personal and property safety, do not short-circuit the positive (+) and negative (-) electrode terminals.



 CAUTION

- Risk of damage due to improper modification
- Use professional tools when operating the products.
- The inverter will become hot during operation. Please do not touch the heat sink or peripheral surface during or shortly after operation.

 NOTICE
· During installation of the battery, circuit breaker must be disconnected from the battery pack wiring.

2.2 Explanations of Symbols

Symbol	Description
	Dangerous electrical voltage This device is directly connected to public grid, thus all work to the battery shall only be carried out by qualified personnel.
	No open flames Do not place or install near flammable or explosive materials.
	Danger of hot surface The components inside the battery will release a lot of heat during operation. Do not touch metal plate housing during operating.
	Attention Install the product out of reach of children
	An error has occurred Please go to Chapter 7 "Troubleshooting" to remedy the error.
	This device shall NOT be disposed of in residential waste
	This battery module shall NOT be disposed of in residential waste

	CE Mark Equipment with the CE mark fulfills the requirements of the Low Voltage Directive and Electro Magnetic Compatibility.
	Recyclable

2.3 Battery Handling

Operate and use the battery properly according to user manual, any attempt to modify battery without the permission from SAJ will void the limit warranty for the battery.

- The battery must be installed at a suitable location with sufficient ventilation
- Do not use the battery if it is defective, damaged or broken.
- Only use the battery with compatible inverter.
- Do not use the battery with other type of battery.
- Make sure the battery is grounded prior to use.
- Do not pull out any cables or open the battery enclosure when the battery is powered on.
- Only use the battery as intended and designed.

2.4 Emergency Situation

Despite of its careful and professional protection design against any hazards, damage of the battery may still possible. If a small amount of battery electrolyte is released due to a serious damage of the outer casing; or if the battery explodes due to not being treated timely after a fire breaks out nearby, and leaks out poisonous gases such as carbon monoxide, carbon dioxide and etc., the following actions are recommended:

- 1) Eye contact: Rinse eyes with a large amount of running water and seek medical advice
- 2) Contact with skin: Wash the contacted area with soap thoroughly and seek medical advice
- 3) Inhalation: If you feel discomfort, dizziness or vomiting, seek medical advice immediately.
- 4) Use a FM-200 or Carbon Dioxide (CO2) fire extinguishers to extinguish the fire if there is a fire in the area where the battery pack is

installed. Wear a gas mask and avoid inhaling toxic gases and harmful substances produced by the fire.

- 5) Use an ABC fire extinguisher, if the fire is not caused by battery and not spread to it yet.

⚠ WARNING

· If a fire has just occurred, try to disconnect the battery circuit breaker and cut off the power supply first, but only if you can do so without endangering yourself.

· If the battery is on fire, do not attempt to extinguish the fire but evacuate the crowd immediately.

Potential danger of damaged battery:

Chemical Hazard: Despite of its careful and professional protection design against any hazard results, rupture of battery may still occur due to mechanical damage, internal pressure etc., and may result in a leakage of battery electrolyte. The electrolyte is corrosive and flammable.

When there is fire, the toxic gases produced will cause skin and eyes irritation, and discomfort after inhalation. Therefore:

- 1) Do not open damaged batteries;
- 2) Do not damage the battery again (shock, fall, trample, etc.);
- 3) Keep damaged batteries away from water (except to prevent an energy storage system from catching fire);
- 4) Do not expose the damaged battery to the sun to prevent internal heating of the battery.

Electrical hazard: The reason of fire and explosion accidents in lithium batteries is battery explosion. Here are the main factors of battery explosion:

- 1) Short circuit of battery. Short circuit will generate high heat inside battery, resulting in partial electrolyte gasification, which will stretch the battery shell. The temperature reaching ignition point of internal material will lead to explosive combustion.
- 2) Overcharge of battery. Overcharge of battery may precipitate lithium metal. If the shell is broken, it will come into direct contact with the air, resulting in combustion. The electrolyte will be ignited at the same time, resulting in strong flame, rapid expansion of gas and explosion.

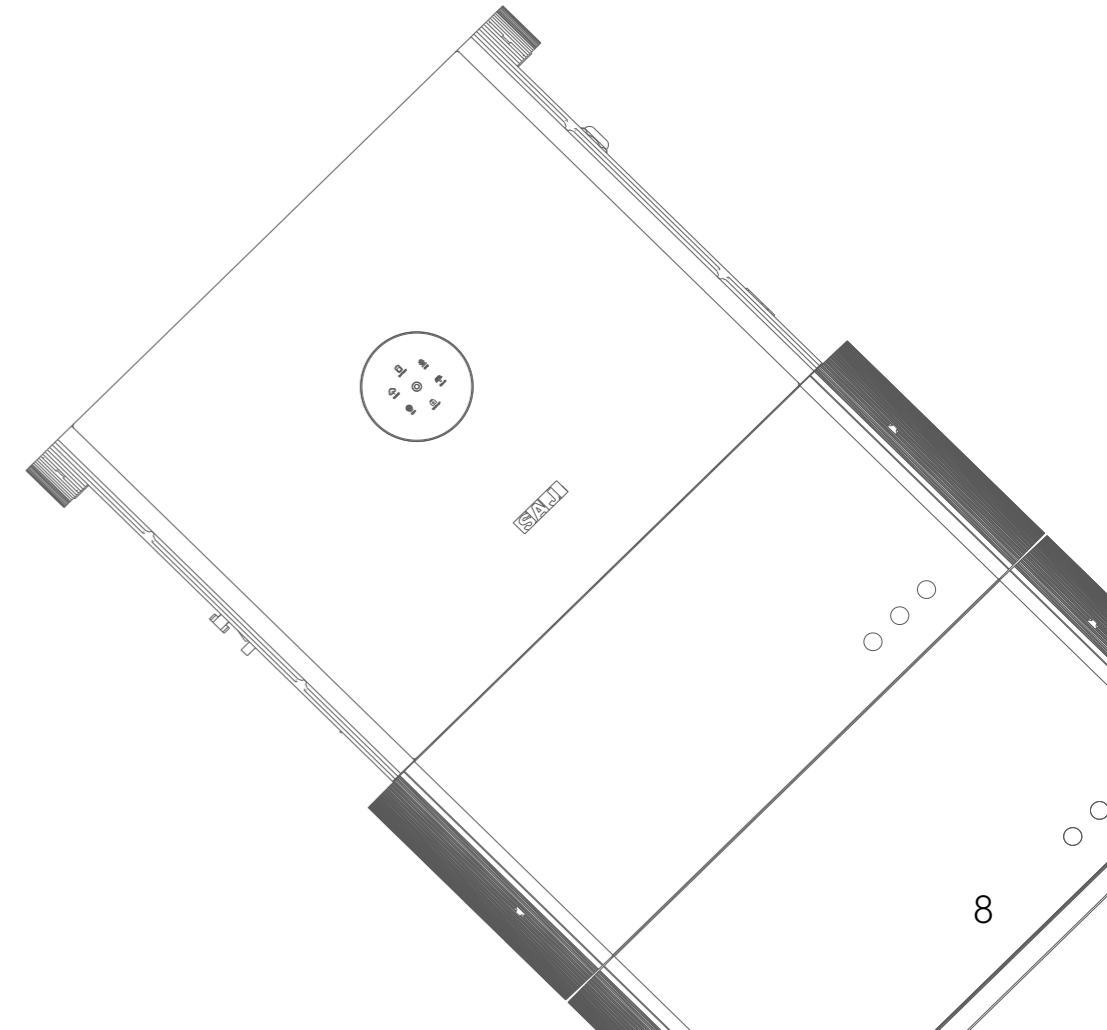

3.

PRODUCT INFORMATION



3.1 Application Scope of Products

The product is included a hybrid inverter/ AC-coupled inverter with battery and it is applied to residential photovoltaic energy storage system. The energy storage system is able to store the energy for future use. It is built internally with a battery management system (BMS), which is used to ensure efficiency of the battery and protect the battery from operating outside its specified limitations.

3.2 Specification for Product Model

HS2/AS2 - **XK** - **T2/T** - **B** - **X**

① ② ③ ④ ⑤

- ① HS2/AS2 represents for product name.
- ② XK represents rated energy XkW of storage system, for example, 5K means 5kW.
- ③ T means three phases, T2 means three phases with 2MPPT
- ④ B indicates this model is ONLY applicable to Belgium
- ⑤ X indicates the number of battery modules (X= 2, 3, 4, 5)

3.3 Overview of Products

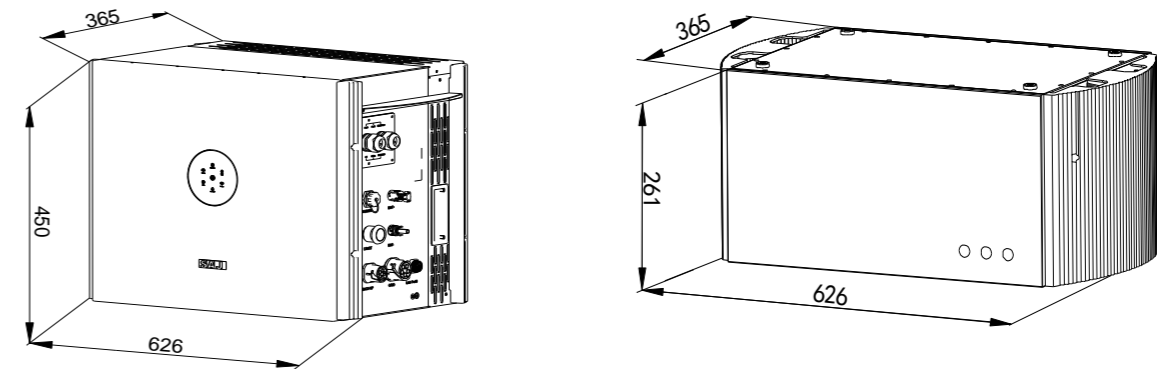

Figure 3.1
Dimensions of HS2/AS2 inverter and battery module

3.4 Terminals Description

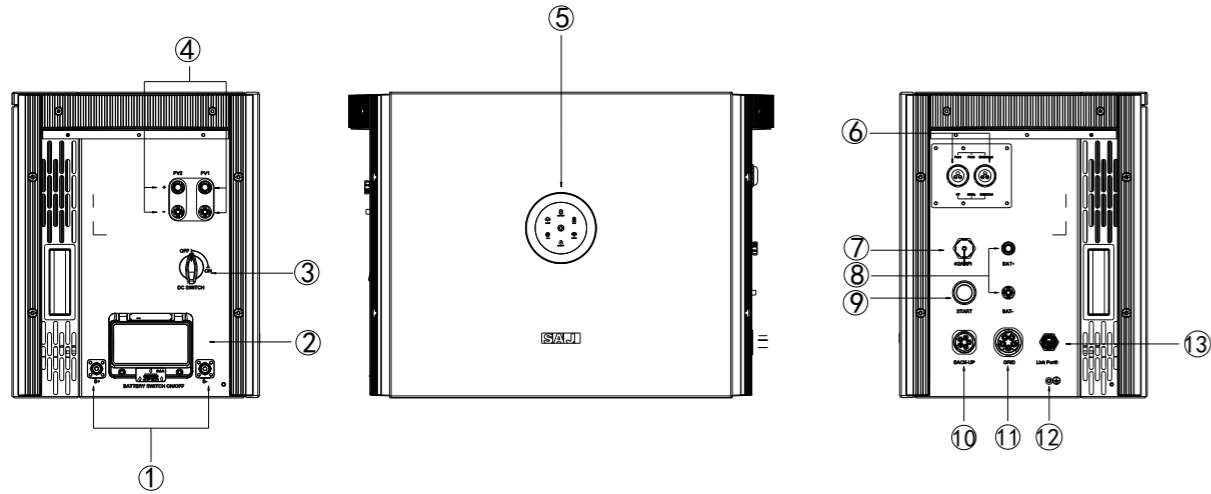

Figure 3.2 HS2 Inverter unit interface (left view and right view)

Position	Name
1	B+/ B- port (to inverter)
2	Battery Switch
3	DC Switch
4	PV Input
5	Display
6	Communication Port
7	4G/ Wi-Fi Module Port Communication Port
8	BAT+/BAT- port (for parallel connection)
9	Start button
10	BACK UP
11	Grid
12	Ground
13	Link Port 0 (to battery module)

Table 3.1 HS2 interface

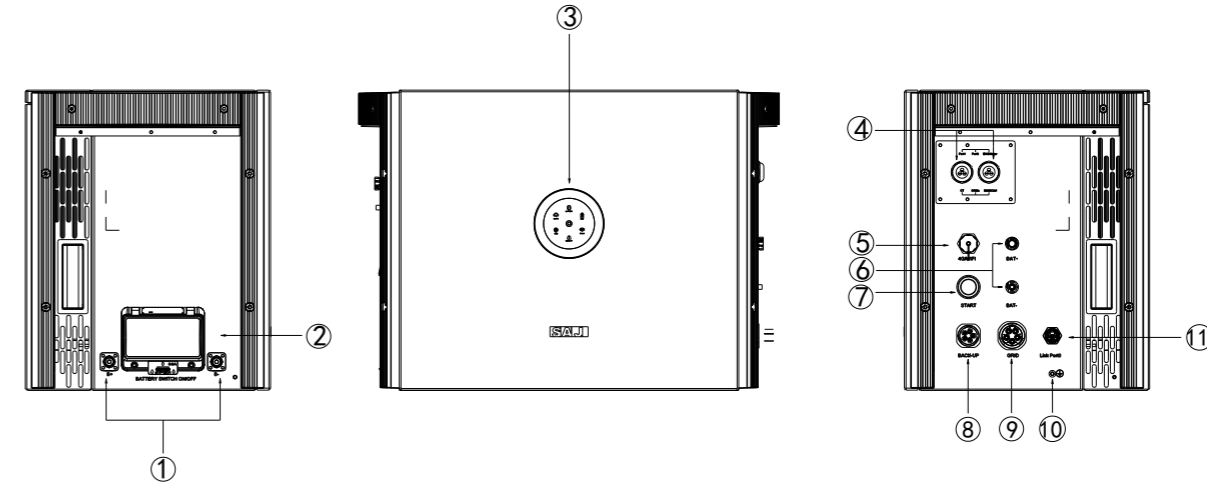

Figure 3.3 AS2 unit interface (left view and right view)

Position	Name
1	B+/ B- port (to inverter)
2	Battery Switch
3	Display
4	Communication Port
5	4G/ Wi-Fi Module Port Communication Port
6	BAT+/BAT- port (for parallel connection)
7	Start button
8	BACK UP
9	Grid
10	Ground
11	Link Port 0 (to battery module)

Table 3.2 AS2 interface

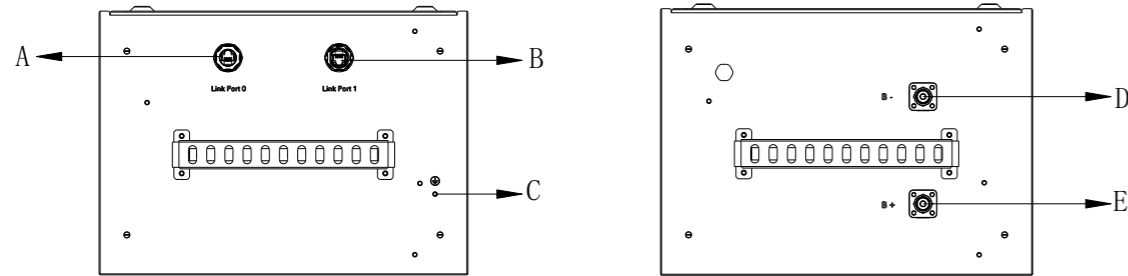

Figure 3.4 Battery module interface (left view & right view)

Code	Name
A	Link Port 0
B	Link port 1
C	Ground port
D	B- port
E	B +port

Table 3.3 Battery module interface

3.5 Datasheet Inverter

Model	HS2-5K-T2-X/ AS2-5K-T-X	HS2-6K-T2-X/ AS2-6K-T-X	HS2-8K-T2-X/ AS2-8K-T-X	HS2-10K-T2-X/ AS2-10K-T-X	HS2-10K-T2-B-X/ AS2-10K-T-B-X
DC Input (For HS2-5-10K-T2-X only)					
Max. PV Array Power [Wp]@STC	7500	9000	12000	15000	15000
Max. DC Voltage [V]	1000				
MPPT Voltage Range [V]	180~900				
Rated DC Voltage [V]	600				
Start Voltage/ Min. Input Voltage[V]	180				
Max. DC Input Current [A]	16/16				
Max. DC Short Circuit Current [A]	19.2/19.2				
No. of MPPT	2				
Battery Parameters					
Battery Type	LiFePO4				
Battery Voltage Range [V]	180~600				
Max. Charging/Discharging Current [A]	30/30				
Scalability	BU2-5.0-HV1/5 (2 to 5 battery modules)				
Short Time Withstand Current/ Conditional Short-circuit Current [A] (For AS2-5-10K-T-X Series Only)	<10000				
AC Output [On-grid]					
Rated AC Power [W]	5000	6000	8000	10000	10000
Max. Apparent Power [VA]	5500	6600	8800	11000	10000
Rated Output Current [A]@230Vac	7.2	8.7	11.6	14.5	14.5
Max. Output Current [A]	8.3	10.0	13.3	16.7	15.2
Current Inrush [A]	52				
Max. AC Fault Current [A]	45				
Max. AC Over Current Protection [A]	20.8	25	33.3	41.8	41.8
Rated AC Voltage/Range [V]	3+N+PE, 220/ 380Vac, 230/ 400Vac				
Rated Output Frequency/Range [Hz]	50,60/45~55,55~65				
Power Factor [cos φ]	0.8 leading ~ 0.8 lagging				
Total Harmonic Distortion [THDi]	<3%				

Model	HS2-5K-T2-X/ AS2-5K-T-X	HS2-6K-T2-X/ AS2-6K-T-X	HS2-8K-T2-X/ AS2-8K-T-X	HS2-10K-T2-X/ AS2-10K-T-X	HS2-10K-T2-B-X/ AS2-10K-T-B-X
AC Input [On-grid]					
Rated AC Voltage/Range [V]	3+N+PE, 220/ 380Vac, 230/ 400Vac				
Rated Input Frequency [Hz]	50,60				
Max. Input Current [A]@230Vac	14.5	17.4	23.2	29.0	29.0
AC Output [Back-up]					
Max. Output Power [VA]	5000	6000	8000	10000	10000
Max. Output Current [A]	8.0	9.6	12.8	15.9	15.9
Peak Output Apparent Power [VA]	10000,60s	12000,60s	16000,60s	16500,60s	16500,60s
Rated AC Voltage/Range [V]	3+N+PE, 220/ 380Vac, 230/ 400Vac				
Rated Output Frequency/Range [Hz]	50,60/45 ~ 55,55 ~ 65				
Output THDv (@ Linear Load)	<3%				
Efficiency					
Max. Efficiency	98.0%				
Euro Efficiency	97.6%				
Protection					
Battery Input Reverse Polarity Protection	Integrated				
Over Load Protection	Integrated				
AC Short Circuit Current Protection	Integrated				
DC Surge Protection	Integrated				
AC Surge Protection	Integrated				
Anti-islanding Protection	Integrated				
AFCI Protection	Optional				
RSD Protection	Optional				
Interface					
PV Connection	D4/MC4 (optional)				
AC Connection	Plug-in connector				
Battery Connection	Quick connector				
Display	LED+APP				
Communication	Wi-Fi/Ethernet/4G(Optional)				
General Parameters					
Topology	Non-isolated				
Operating Temperature Range	-10 ~ 50°C, >45 °C derating				
Cooling Method	Natural Convection				
Ambient Humidity	0-100% Non-condensing				
Altitude	4000m (>3000m Power Derating)				

Model	HS2-5K-T2-X/ AS2-5K-T-X	HS2-6K-T2-X/ AS2-6K-T-X	HS2-8K-T2-X/ AS2-8K-T-X	HS2-10K-T2-X/ AS2-10K-T-X	HS2-10K-T2-B-X/ AS2-10K-T-B-X
Noise [dBA]	<30				
Ingress Protection	IP65				
Dimensions [H*W*D] [mm]	450*626*365				
Weight [kg]	33 (HS2), 32.5 (AS2)				
Warranty [Year]	Refer to the warranty policy				
Standard	EN62109-1/2, EN61000-6-1/2/3/4, EN50438, EN50549, C10/11, IEC62116, IEC61727, RD1699, RD413, UNE 206006, UNE 206007, NTS, CEI 0-16, AS4777.2, NBR16149, NBR 16150 VDE-AR-N 4015, VDE 0126-1-1				

Note: X indicates the number of battery modules (X=2, 3, 4, 5)

Battery

Model	BU2-10.0-HV1/ BU2-10.0-HV5	BU2-15.0-HV1/ BU2-15.0-HV5	BU2-20.0-HV1/ BU2-20.0-HV5	BU2-25.0-HV1/ BU2-25.0-HV5
Battery Module	BU2-5.0-HV1/5 (1P32S 102.4V 50Ah)			
No. of Modules	2	3	4	5
Rated Energy [kWh]	10.0	15.0	20.0	25.0
Usable Energy [kWh]	9.0	13.5	18.0	22.5
Dimension (H*W*D)[mm]	522*626*365	783*626*365	1044*626*365	1305*626*365
Weight [kg]	101/105	151.5/157.5	202/210	252.5/262.5
Nominal Voltage [V]	204.8	307.2	409.6	512
Operating Voltage [V]	179.2 ~ 230.4	268.8 ~ 345.6	358.4 ~ 460.8	448 ~ 576.0
Max. Charge Current [A]	30			
Max. Discharge Current [A]	30			
General Data				
Ingress Protection	IP65			
Mounting	Wall-Mounted / Ground-Mounted			
Operating Temperature Range	Charging: 0 ~ 50°C; Discharging: -10 ~ 50°C			
Ambient Humidity	0 ~ 95% non-condensing			
Cooling Method	Natural convection			
Communication	CAN			
Warranty [Year]	Refer to the warranty policy			
Applicable Standard	IEC62619(Cell&Pack)/EN62477-1/EN61000-6-1/2/3/4/UN38.3			

4.

INSTRUCTIONS FOR INSTALLATION



4.1 Unpacking and Inspection











4.1.1 Checking the Package



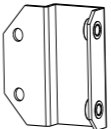

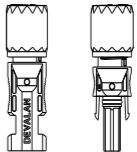
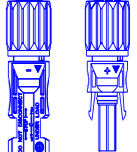

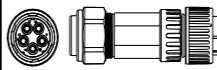
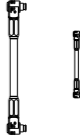
Although SAJ's product have thoroughly tested and checked before delivery, it is uncertain that the product may suffer damages during transportation. Please check the package for any obvious signs of damage, and if such evidence is present, do not open the package and contact your dealer as soon as possible

4.1.2 Scope of Delivery

Please contact after sales if there are missing or damaged components.







Inverter Package

			
HS2/AS2 Inverter*1	M5*12 screw*4 M6*12 screw*4	Expansion bolt M10*80 screw*2	Documents
			
Locking bracket (inverter)*2	Locking bracket (wall) *2	PV connector*4 (For HS2 inverter only)	Battery connector*2
			
Grid connector*1	Backup connector*1	Power cable*1 (1450mm) Power cable*1 (150mm)	Grounding cable*1

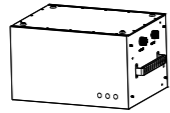
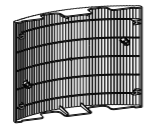
			
Smart meter*1	Current transformer*3	Meter COMM cable*1 (1000mm)	120Ω resistor*1
			
RJ45 plug*1	COMM cable*1	Communication module*1 (Optional)	

The documents include the user manual and packaging list.

Battery Module Package

			
Battery module*1	Side cover*2	M4*25 screw*4	Power cable*2
			
COMM cable*1	Locking bracket*2	Grounding cable*1	M4*10 screw*4

4.2 Installation Method and Position

4.2.1 Installation Position and Clearance

This device is cooled by natural convection and suggested an indoor installation or an installation under a sheltered place to prevent the product from exposure to direct sunlight, rain and snow erosion.

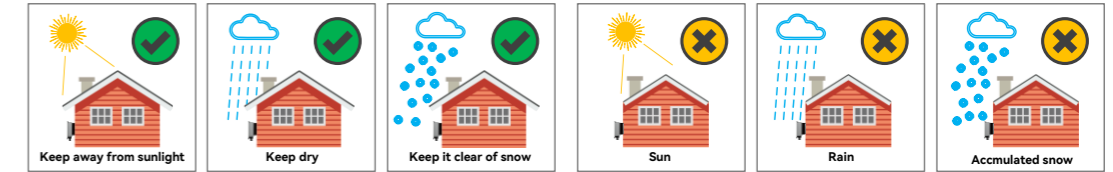

Figure 4.1
Installation location

Please reserve enough clearance around the product to ensure a good air circulation at the installation area. Because poor air ventilation will affect the working performance of internal electronic components and shorten the service life of the system.

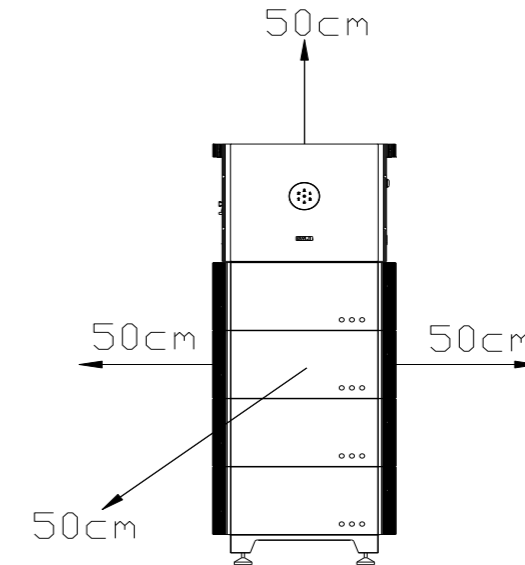

Figure 4.2
Installation clearance

4.2.2 Mounting Method

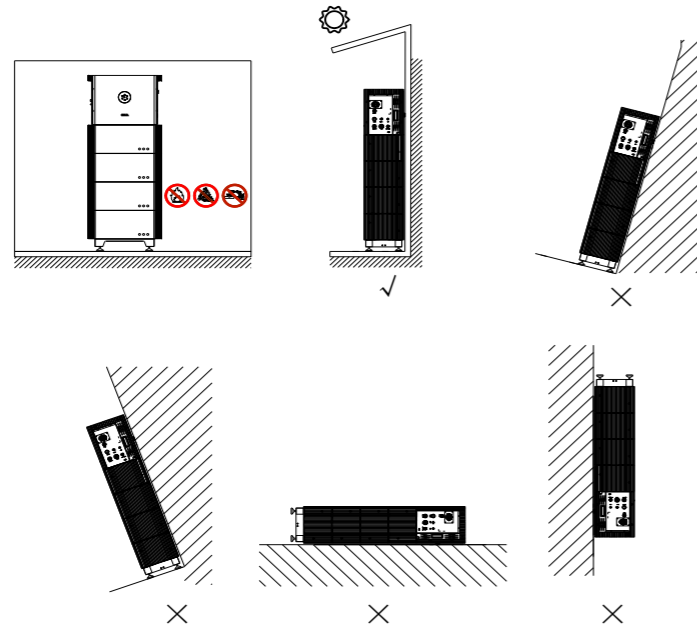

Figure 4.3
Mounting method

- ① The equipment employs natural convection cooling, and it can be installed indoor or outdoor.
- ② Mount vertically. Never install the device tilted forwards, sideways, horizontally or upside down.
- ③ When mounting the device, please consider the solidity of wall for product, including accessories, make sure the wall has enough strength to hold the screws and bear the weight of products. Please ensure the mounting bracket mounted tightly.

Installation Environment Requirements

- The installation environment must be free of inflammable or explosive materials.
- Install the device away from heat source.
- Do not install the device at a place where the temperature changes extremely.

- Keep the device away from children.
- Do not install the device at daily working or living areas, including but not limited to the following areas: bedroom, lounge, living room, study, toilet, bathroom, theater and attic.
- When installing the device at the garage, please keep it away from drive way.
- Keep the device from water sources such as taps, sewer pipes and sprinklers to prevent water seepage.
- The product is to be installed in a high traffic area where the fault is likely to be seen.

Note: When installing outdoors, the height of the device from the ground should be considered to prevent the device from soaking in water. The specific height is determined by the site environment.

4.3 Mounting Procedure

After Installation, you are suggested to tick in the right box (☐) on the system label according to the number of battery modules.

4.3.1 Installation Tools

Installation tools include but are not limited to the following recommended ones. Please use other auxiliary tools on site if necessary.

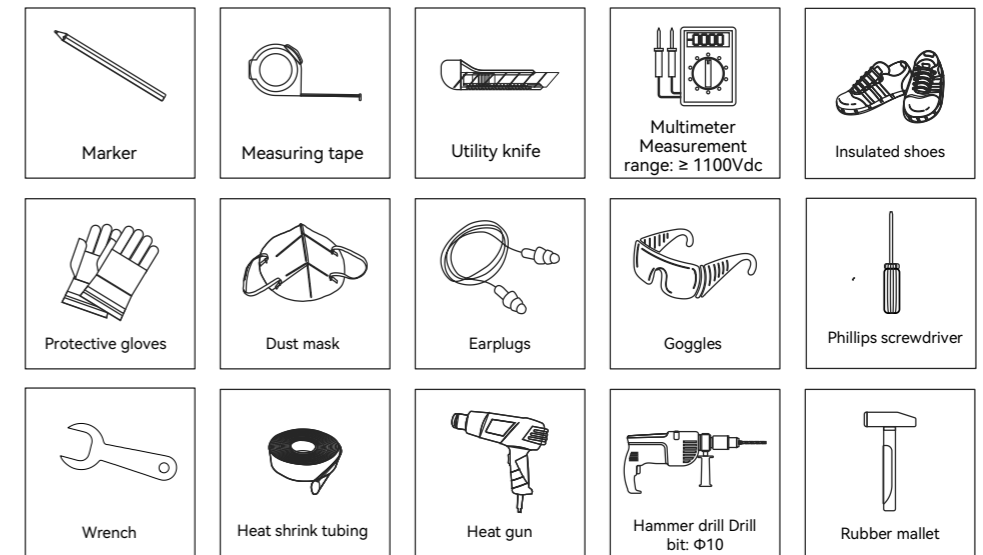

4.3.2 Mounting Procedures

The product employs either ground mounting or wall mounting and its position is determined by the drilled holes of bracket.

Ground Mounting

The ground should be flat and no inclination.

Step 1: Assemble the base. Adjust the height of foot cup, make sure the surface of base is horizontal.

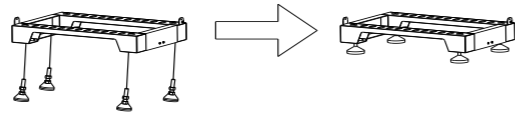

Figure 4.4
Assembling the base

Step 2: Place the base on the ground, make sure the edge of base is 28~34mm away from wall. Place the battery module on the base and secure it with screws (M4*10).

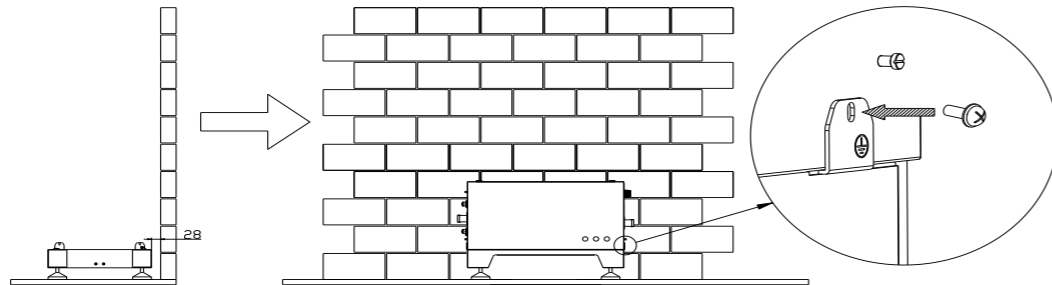

Figure 4.5
Securing the battery

Step 3: Stack the rest of the battery modules up and secure the battery modules with locking brackets (M4*10)

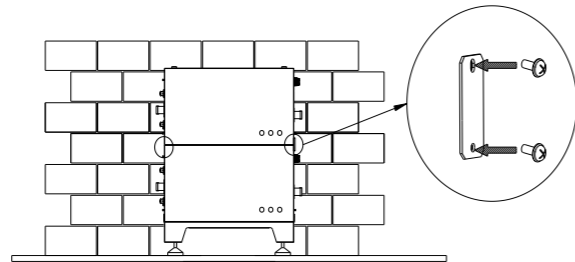
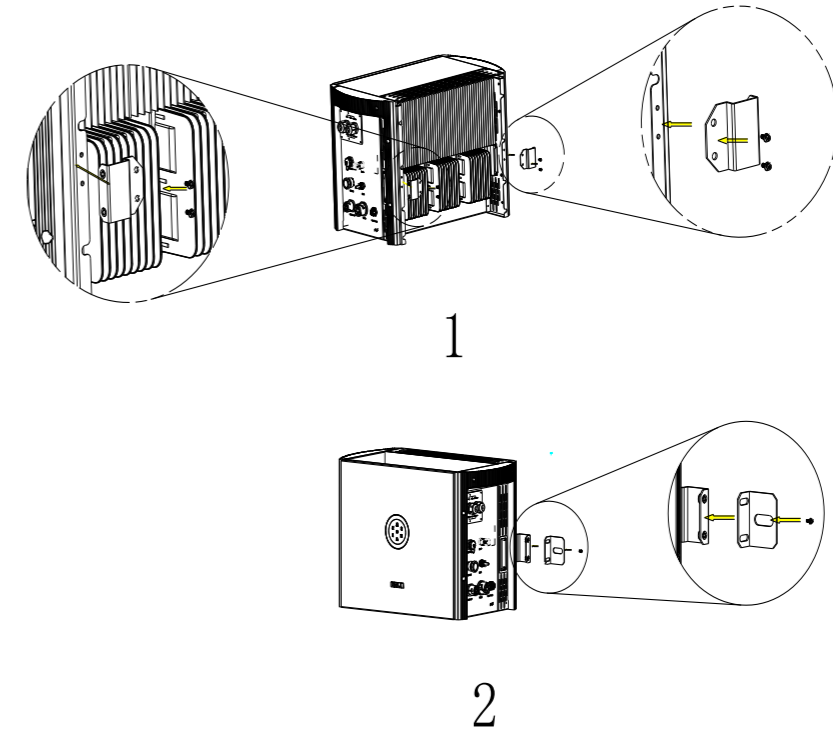

Figure 4.6
Securing battery modules
with locking brackets

Step 4: Install the locking brackets (inverter) with screws (M6*12) onto the inverter, and then install the locking brackets (wall) onto the locking brackets (inverter) with screws (M6*12).

Figure 4.7
Securing inverter



Step 5: After the battery modules installation, mark the proper positions of inverter and drill holes (10mm in diameter, 65mm in depth) on those positions by using the inverter as a template. Remove the rubber feet for the top battery module before installing inverter.

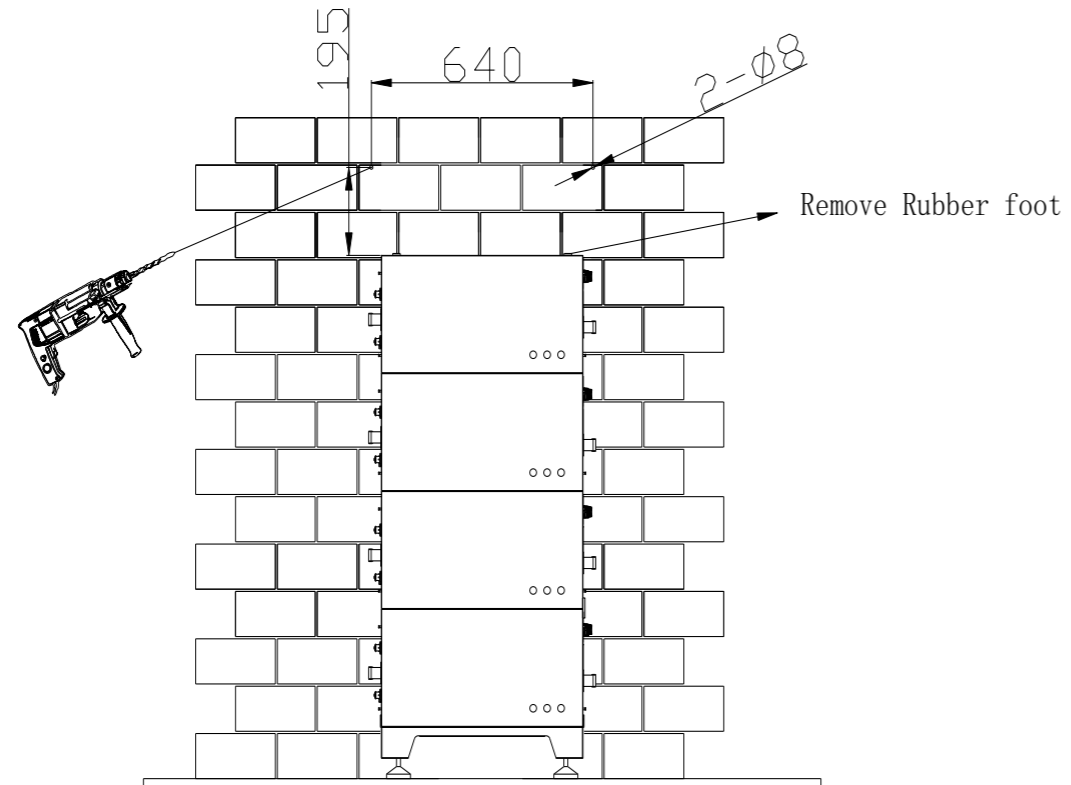

Figure 4.8
Drilling holes to install
inverter

Step 6: Use a rubber hammer to drive the screw fixing seat into the holes to fix the bracket, use the wrench to tighten the screws (M10*80 screw) to secure the inverter. Secure the locking bracket and inverter with screw (M6*12).

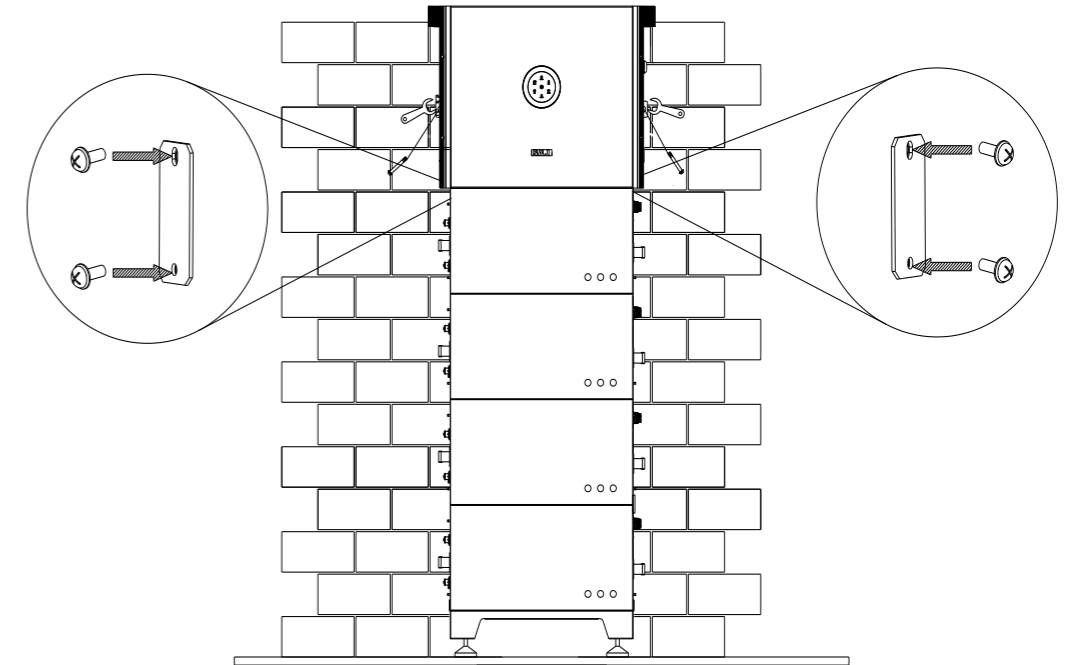

Figure 4.9
Installing inverter

Wall Mounting

Make sure that the wall is capable of mounting screws and supporting the weight of the battery pack before installation. For safety reason, solid wall is recommended for wall mounting, cavity wall and timber wall are not allowed to install the battery system.

Step 1: Assemble the bracket and secure it with screws

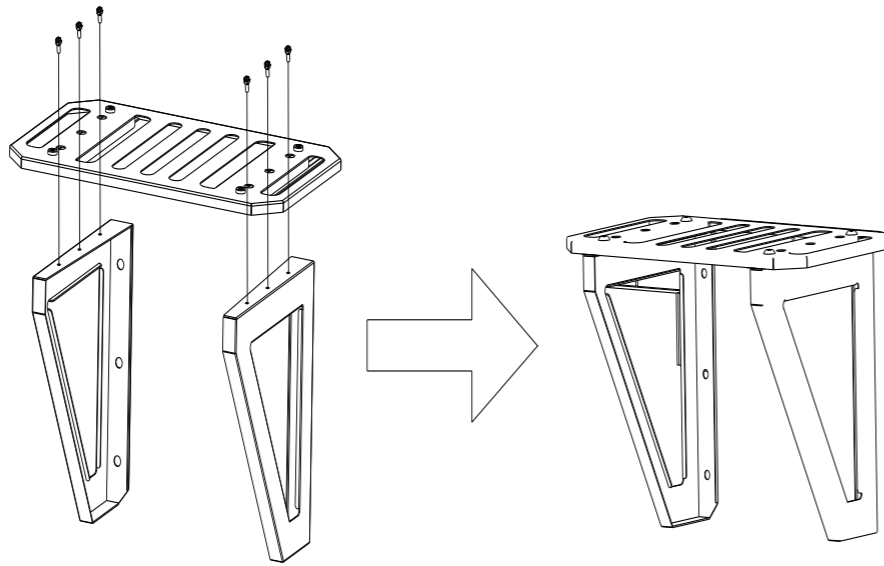

Figure 4.10
Assembling the bracket

Step 2: Mark the proper positions of mounting bracket and drill holes on those positions (14mm in diameter, 65mm in depth) by using the mounting bracket as a template, and then use a rubber hammer to drive the screw fixing seat into the holes to fix the bracket.

Note: It is recommended to leave no gap between the bracket and ground.

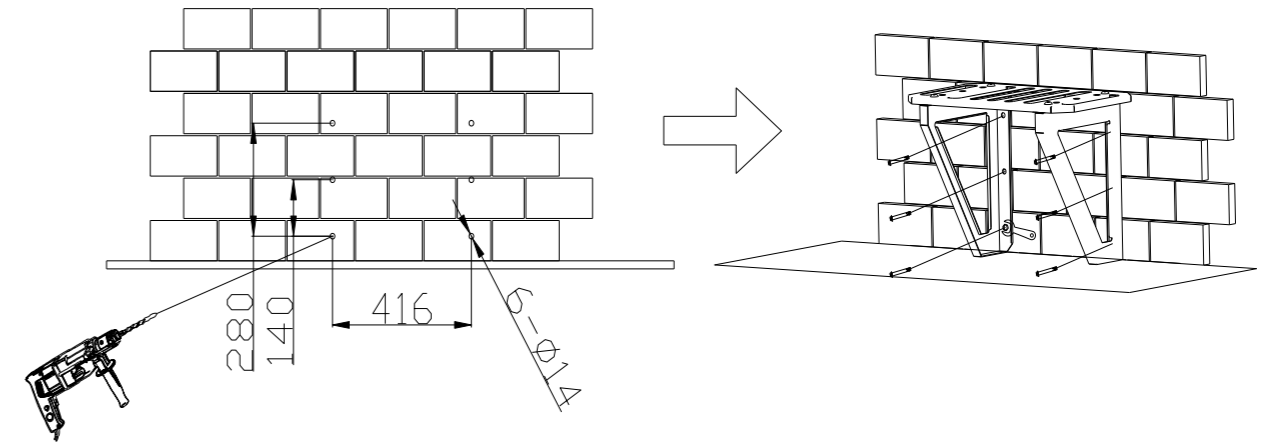

Figure 4.11
Drill holes' dimensions of
bracket

Step 3: Install the battery module on the bracket, make sure the battery module position fits with the position of rubber feet on bracket, and use a screw (M4*10) to secure it with locking brackets.

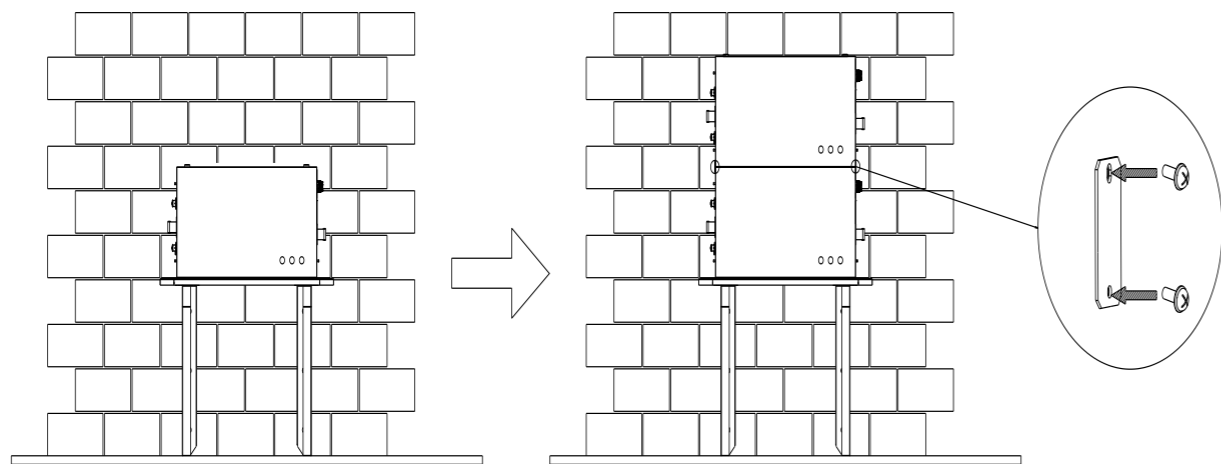

Figure 4.12
Install the locking bracket

Step 4: Install the locking brackets (inverter) with screws (M6*12) onto the inverter, and then install the locking brackets (wall) onto the locking brackets (inverter) with screws (M6*12).

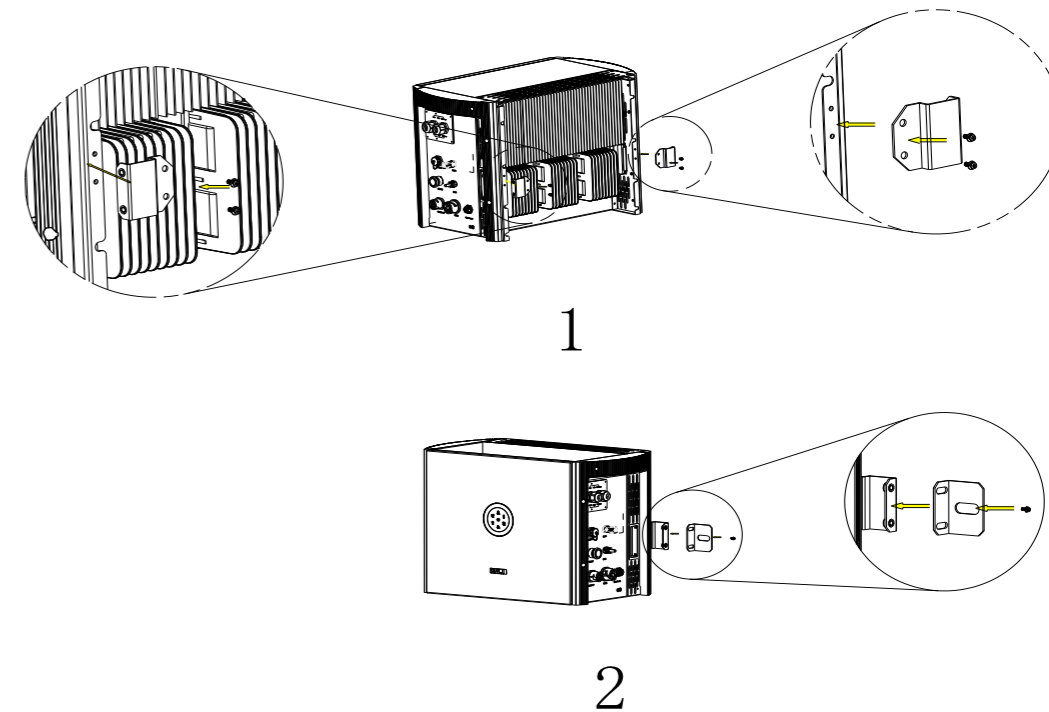

Figure 4.13
Securing inverter

Step 5: After the battery modules installation, mark the proper positions of inverter and drill holes (10mm in diameter, 65mm in depth) on those positions by using the inverter as a template. Remove the rubber feet for the top battery module before installing inverter.

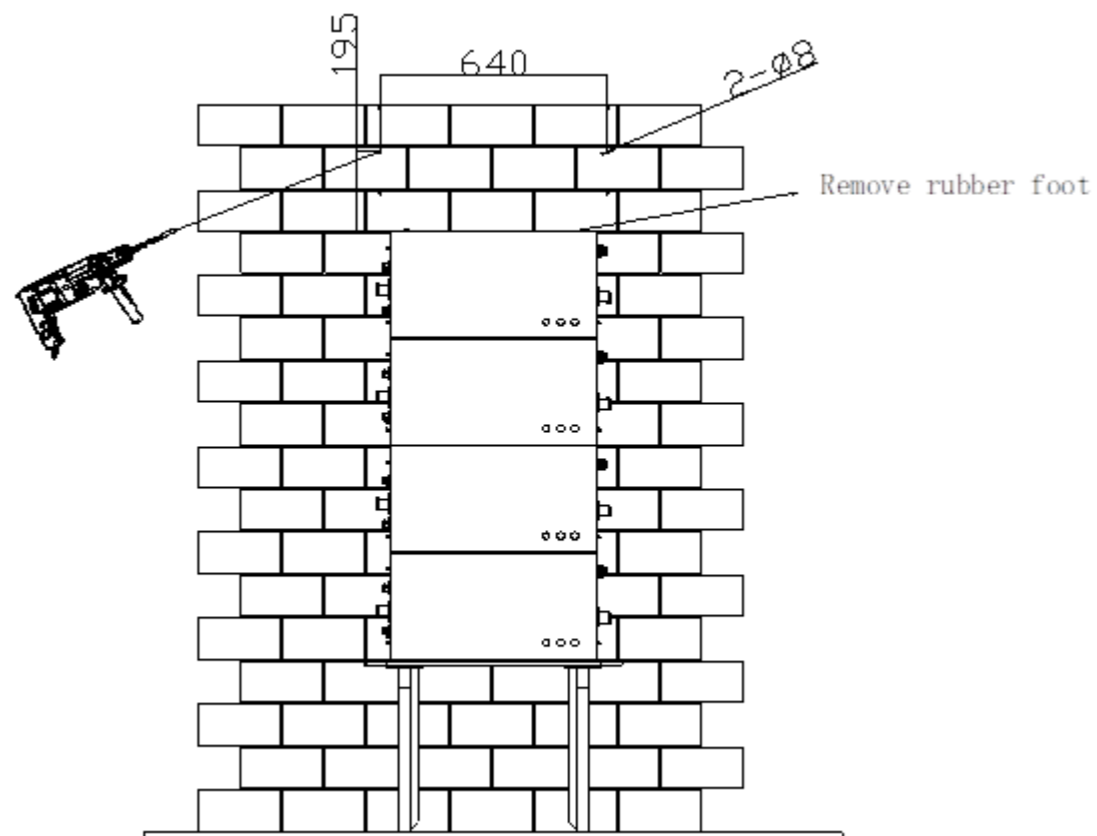

Figure 4.14
Drilling holes for installation of
Inverter

Step 6: Use a rubber hammer to drive the screw fixing seat into the holes to fix the bracket, use the wrench to tighten the screws (M10*80 screw) to secure the inverter. Secure the locking bracket and inverter with screw (M6*12).

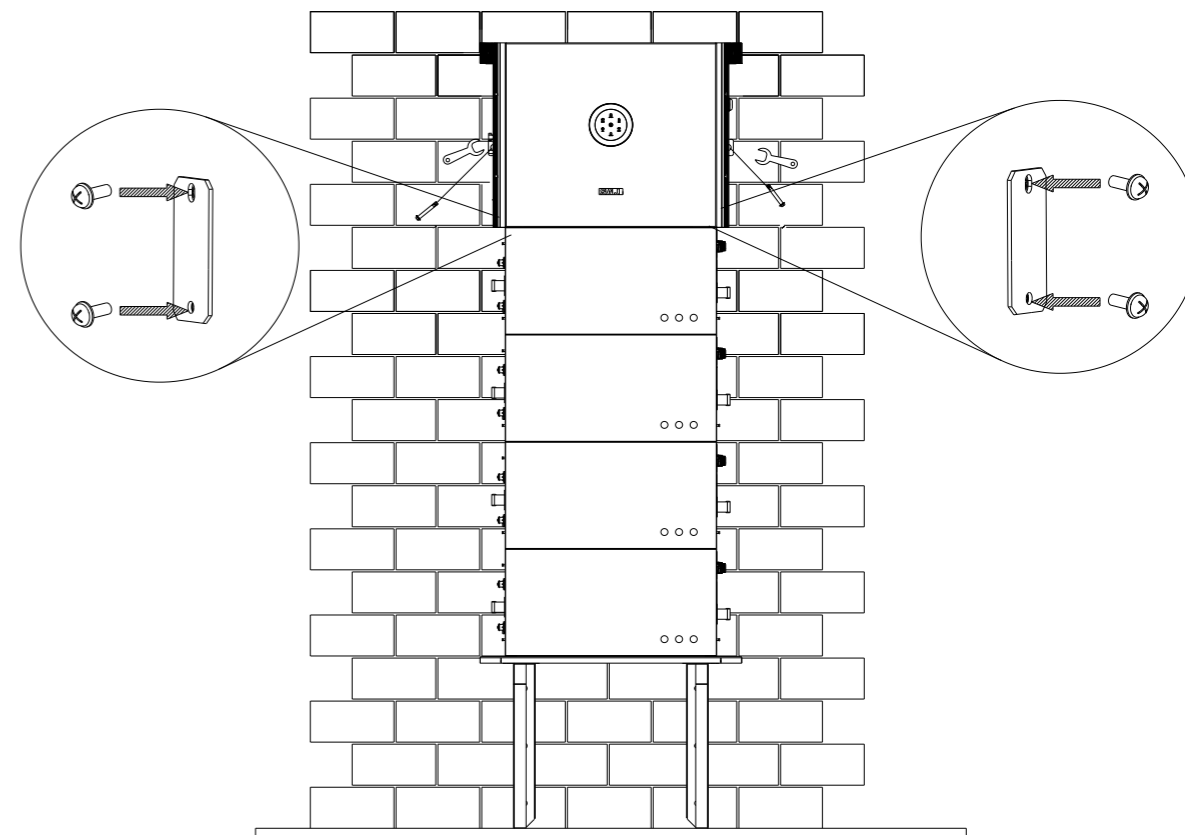

Figure 4.15
Installing inverter

5.

ELECTRICAL CONNECTION



5.1 Additional Grounding Cable

Electrical connection must only be operated by professional technicians. Before connection, necessary protective equipment must be employed by technicians, including insulating gloves, insulating shoes and safety helmet.

WARNING

· Connect this additional grounding cable before other electrical connection.

Note: The additional cable and OT/DT terminal should be prepared by user themselves.

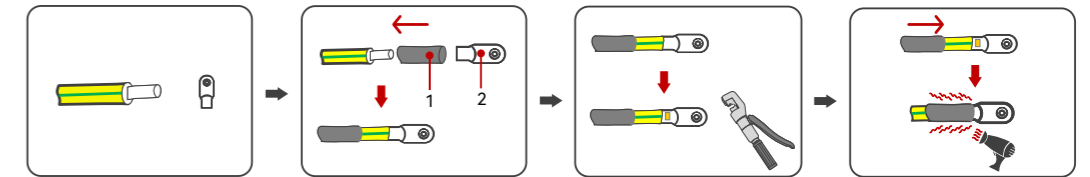

Figure 5.1
Preparing additional grounding cable

1. Heat shrink tubing 2. OT/DT terminal

Remove the screw of grounding terminal and secure the additional grounding cable by insert a screw into the screw hole in the OT/DT terminal. Connect the grounding cables as the following diagram.

Note: A 4 mm² conductor cross-sectional area of cable is recommended for additional grounding cable.

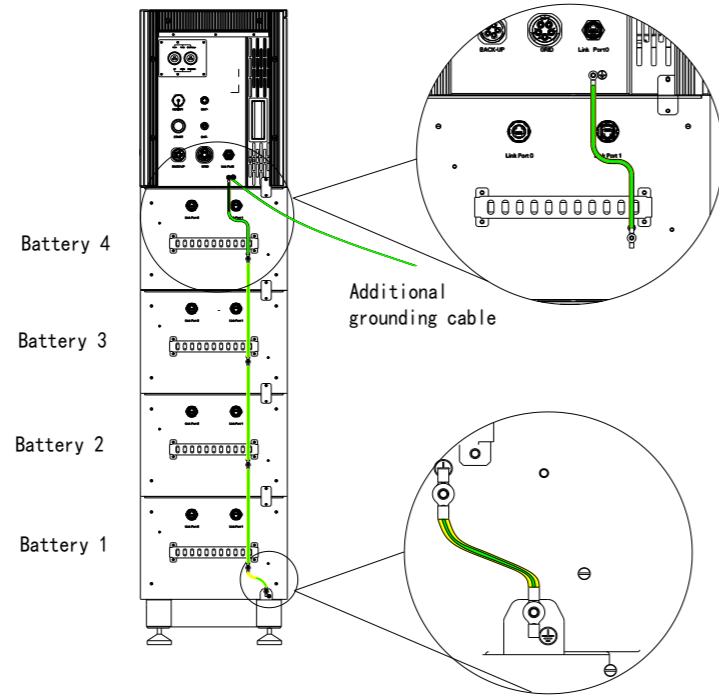

Figure 5.2
Connecting the additional
grounding cable

5.2 AC Grid Wire and Backup Output Connection

Conductor cross-sectional area of cables (mm ²)		Conductor material
Scope	Recommended value	Copper
2.5~6.0	4.0	

Table 5.1
Recommended AC cable specification

Note: If the grid-connection distance is too far, please select an AC cable with larger diameter as per the actual condition.

Power cable connection procedure:

- Step 1&2: Plug in the assembly and disassembly tool to separate the locking nut and cable gland body
- Step 3: Pull the assembly and disassembly tool out
- Step 4: Unlock the sealing nut
- Step 5: Strip the insulation off the wires with 13mm length
- Step 6: Thread the cable through the cable gland and secure the wires with spanner
- Step 7: Connect the cable to the inverter
- Step 8: (Only applicable to market in Australia) During off grid operation time, PE line at the BACK-UP end will remain to be connected with the PE line at the power grid end inside the inverter.

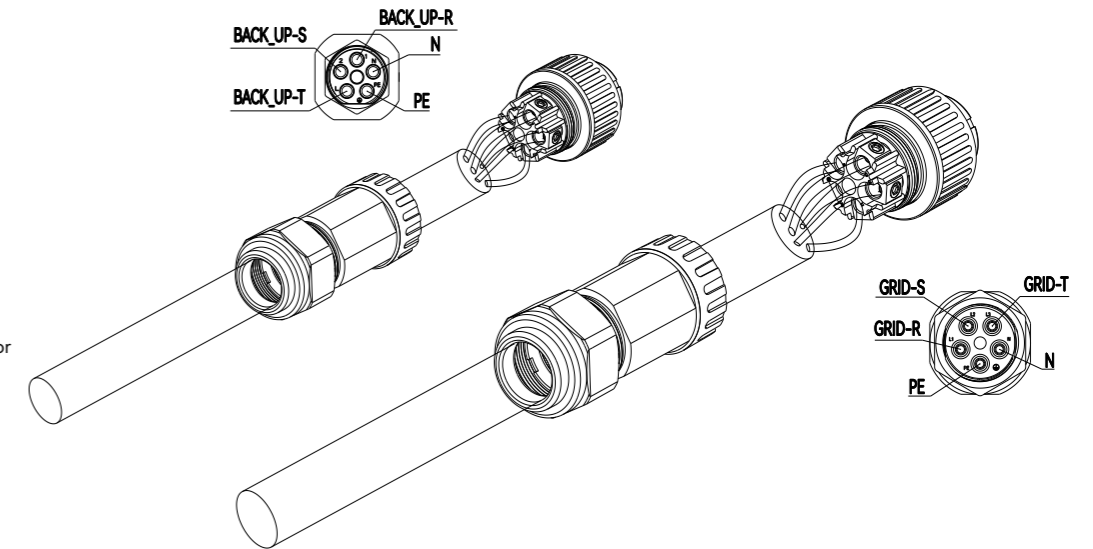

Figure 5.3
Assembling the AC/backup connector

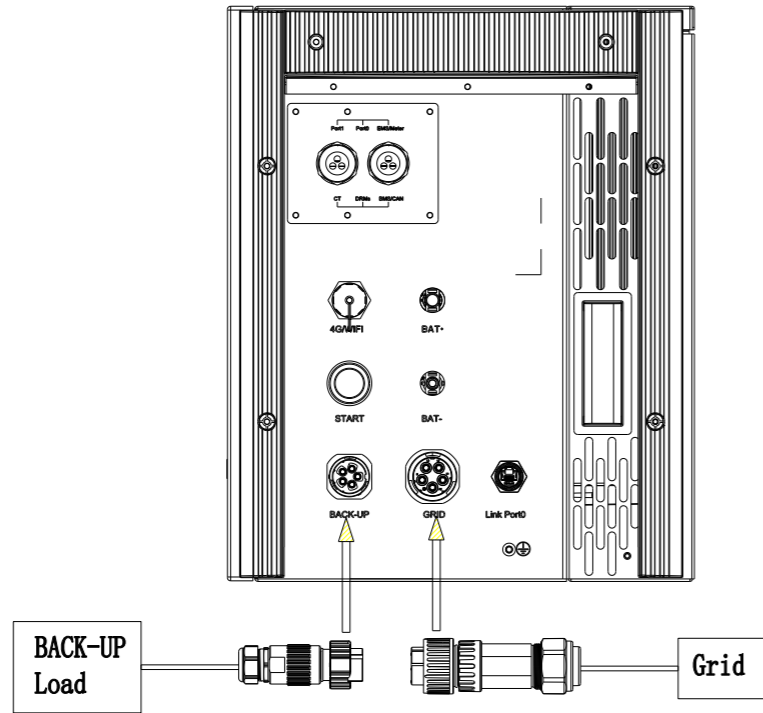

Figure 5.4
Connecting the AC/backup
connector

5.2.1 Earth Fault Alarm

This inverter complies with IEC 62109-2 clause 13.9 for earth fault alarm monitoring. If an Earth Fault Alarm occurs, the ring light will be lit up in red and error code <31> will be displayed on LED panel 1 until the error being solved and inverter functioning properly.

Note: The inverter cannot be used with functionally earthed PV Arrays.

5.2.2 External AC Circuit Breaker and Residual Current Device

Please install a circuit breaker to ensure the inverter is able to disconnect from grid safely. The integrated leakage current detector of inverter is able to detect the real time external current leakage. When a leakage current detected exceeds the limitation, the inverter will be disconnected from grid quickly. The inverter does not require an external residual current device, as it has integrated with a RCMU. If local regulations require the application of external residual current device, either type A or type B RCD is compatible with the inverter. The action current of external residual current device should be 300mA.

Inverter type	Recommended breaker specification
HS2-5-10K-T2-X	63A
Notice: Do not connect multiple inverters to one AC circuit breaker.	

Table 5.2
Recommended circuit breaker specification

5.3 PV Side Connection (Applicable for HS2 Series)

WARNING
· Make sure the PV array is well insulated to ground before connecting it to the inverter.

Conductor cross-sectional area of cables (mm ²)		Conductor material
Scope	Recommended value	Outdoor multi-core copper wire cable, complying with 600Vdc
4.0~6.0	4.0	

Table5.3
Recommended specifications of DC cable

PV Connector Assembly

⚠ WARNING

Dangerous to life due to electric shock when live components or DC cables are touched.

- The PV panel string will produce lethal high voltage when exposed to sunlight. Touching live DC cables results in death or lethal injuries.
- DO NOT touch non-insulated parts or cables
- Disconnect inverter from voltage sources.
- DO NOT disconnect DC connectors under load.
- Wear suitable personal protective equipment for all work.

DC connector is made up of positive connector and the negative connector



Figure 5.5
Positive connector
& Negative connector

⚠ NOTICE

- Please place the connector separately after unpacking in order to avoid confusion for connection of cables.
- Please connect the positive connector to the positive side of the solar panels, and connect the negative connector to the negative side of the solar side. Be sure to connect them in right position.

Connecting Procedures:

1. Loosen the lock screws on positive and negative connector.
2. Strip the insulation of the positive and negative cables with 8-10mm length.

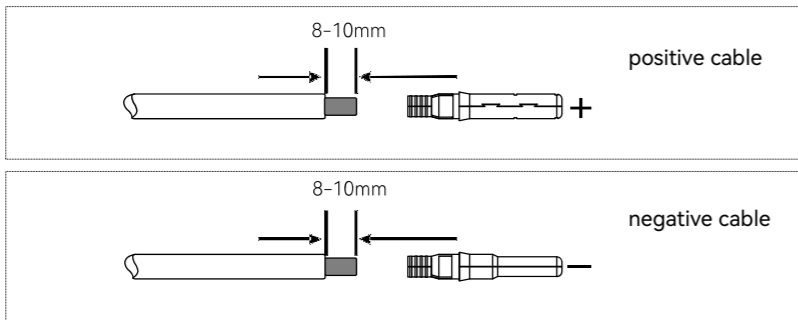

Figure 5.6
Stripping off the insulation skin of cables

3. Assembly the positive and negative cables with corresponding crimping pliers.

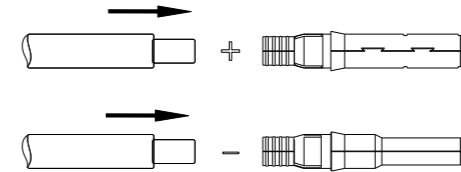

Figure 5.7
Inserting cables to lock screws

4. Insert the positive and negative cable into positive and negative connector. Gently pull the cables backward to ensure firm connection.

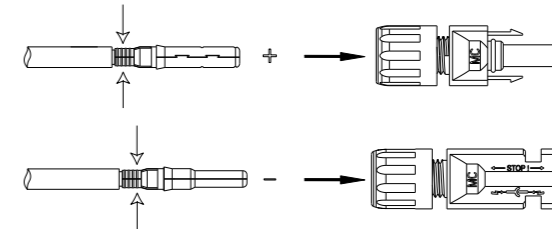

Figure 5.8
Inserting crimped cables to connectors

5. Fasten the lock screws on positive and negative connectors.

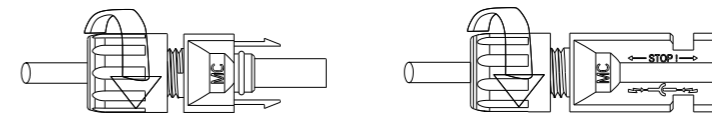

Figure 5.9
Securing the connectors

6. Make sure the DC switch is at OFF position

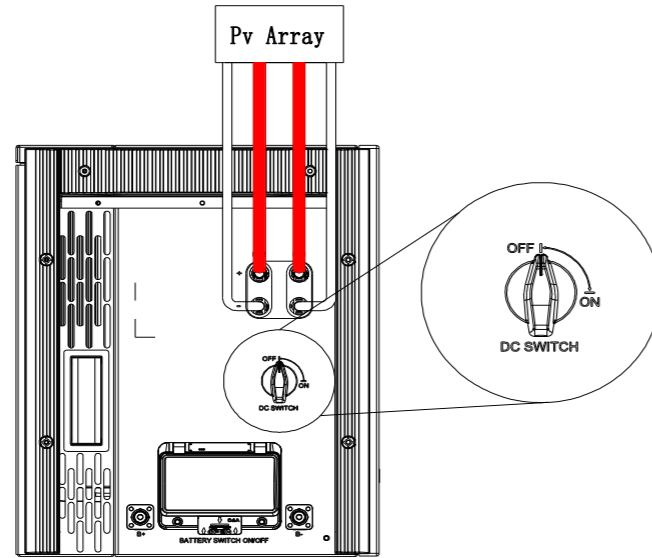

Figure 5.10
DC switch

7. Connect the positive and negative connectors into positive and negative DC input terminals of the inverter, a “click” should be heard or felt when the contact cable assembly is seated correctly.

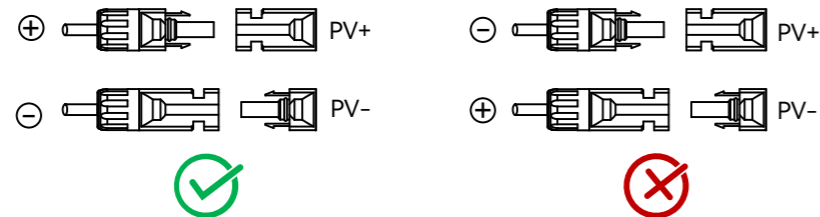

Figure 5.11
Plug in PV connectors

5.4 Communication Connection

- Note: 1) The communication cable is one end crimped, this crimped end is for battery side connection. The other end is for inverter side connection. Customer should crimp the other end of communication cable by themselves.
- 2) Confirm that the DC switch is OFF during installation to avoid short circuit caused by wrong operation during battery wiring.
- 3) Please use the battery cable in original package.

PORT1		
1	NC	1 2 3 4 5 6 7 8
2	NC	
3	NC	
4	NC	
5	NC	
6	NC	
7	NC	
8	NC	

PORT0		
1	NC	1 2 3 4 5 6 7 8
2	NC	
3	NC	
4	NC	
5	NC	
6	NC	
7	NC	
8	NC	

EMS/METER		
1	RS485-A+	1 2 3 4 5 6 7 8
2	RS485-B-	
3	NC	
4	NC	
5	NC	
6	NC	
7	RS485-A+	
8	RS485-B-	

CT		
1	R/CT.1+	1 2 3 4 5 6 7 8
2	R/CT.1-	
3	S/CT.1+	
4	S/CT.1-	
5	T/CT.1+	
6	T/CT.1-	
7	NC	
8	NC	

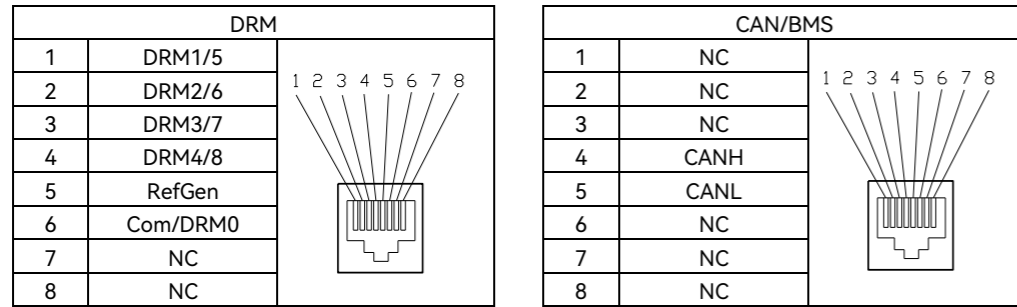

Thread the communication cable through the waterproof cable gland and connect to the corresponding port.

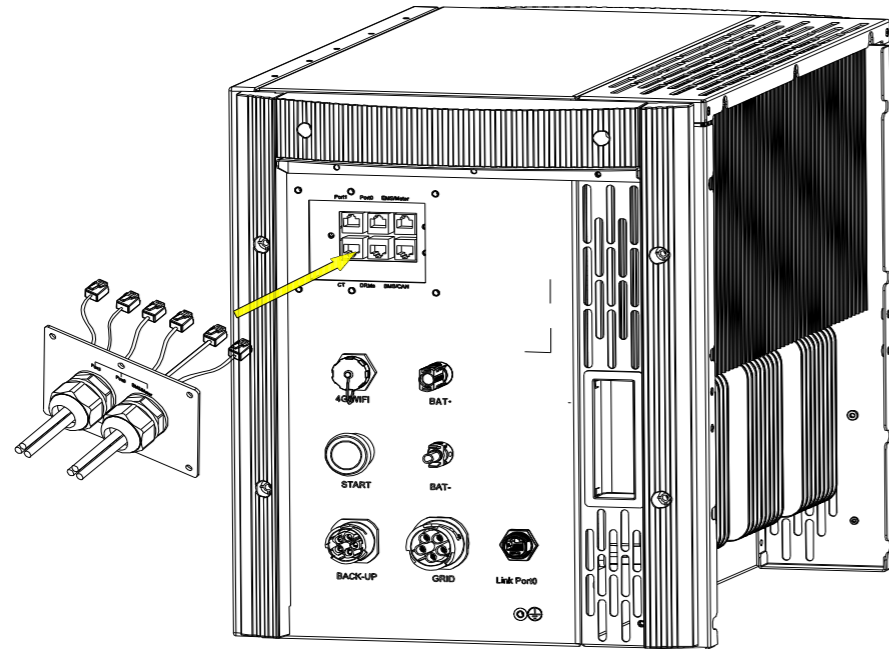

Figure 5.12
Communication cable connection

Communication Module Installation

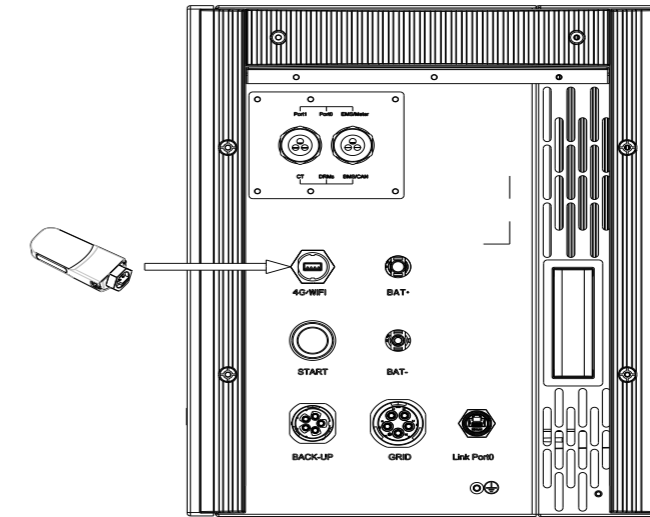

Figure 5.13
4G/WiFi port

Plug in the communication module to 4G/WIFI port and secure the module by rotating the nut.

1. 4G/Wi-Fi port could be externally connected with eSolar 4G module, eSolar Wi-Fi module or eSolar AIO3 module, for operation in details please refer to communication module Quick Installation Guide in <https://www.saj-electric.com/>.

5.5 Connecting Battery COMM Cable

- Step1: Connect link port 0 of inverter to link port 1 of battery 4 (the battery number can be varied, it should be depended on the number of battery modules in the system)
- Step 2: Repeat step 1 to connect the rest of the battery modules
- Step 3: Insert a RJ45 plug to link port 0 of battery 1
- Note: If the RJ45 plug is not installed, a communication error will occur.

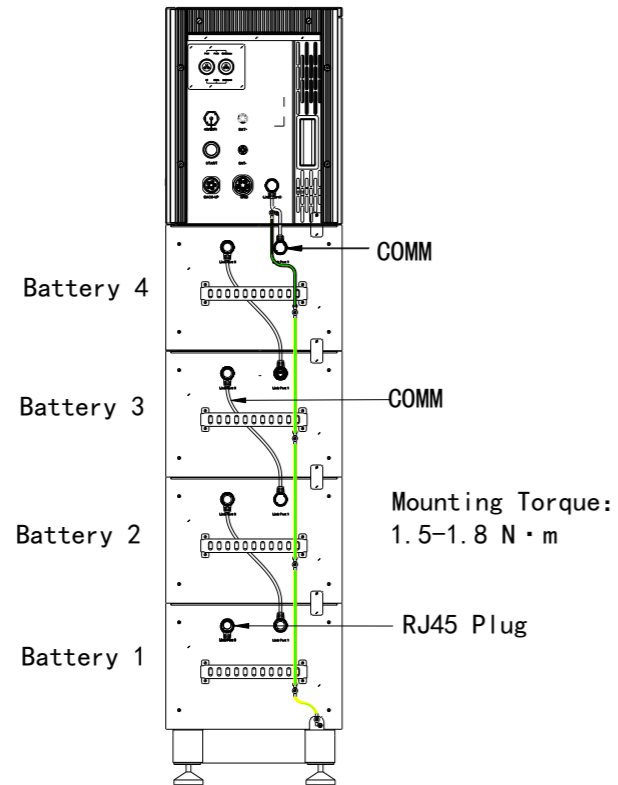

Figure 5.14
Connecting battery COMM cable

5.6 Connecting Battery Power Cable

- Power off the battery system before connecting the power cable to avoid high voltage danger
- The electrical connection of high voltage battery systems must be operated by qualified technicians in accordance with local and national power grid standards and regulations.

- Step 1: Connect the power cable from B- port of inverter to B- port of the battery 4 (the battery number can be varied, it should be depended on the number of battery modules in the system).
- Step 2: Connect power cable from B+ port of battery 4 to B- port of battery 3.
- Step 3: Repeat step 2 to connect the rest of the battery modules.
- Step 4: Connect the B+ of inverter to B+ of battery 1.
- Note: Please follow the following diagrams to connect cables.

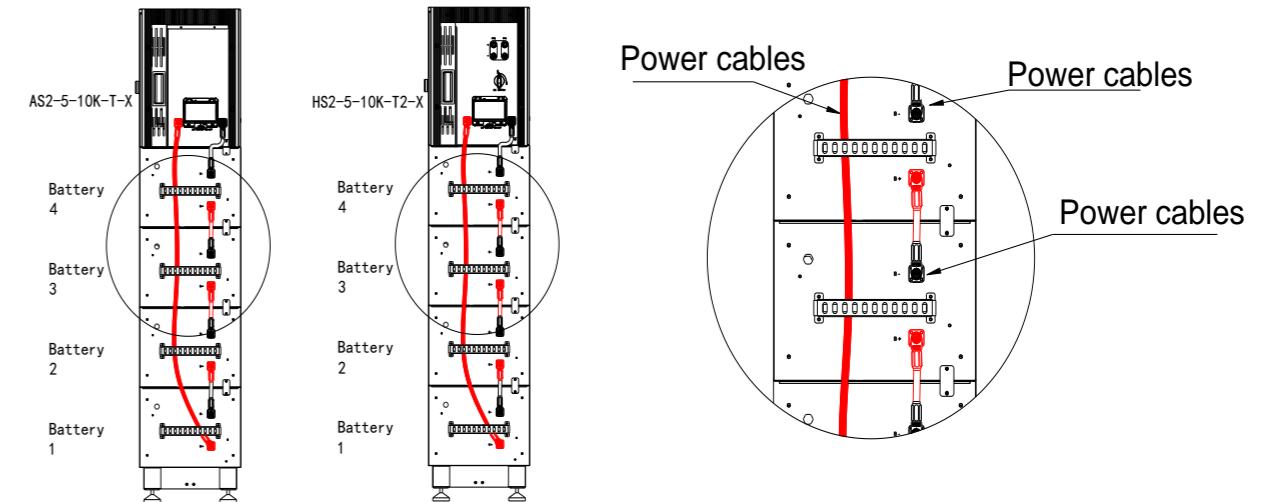
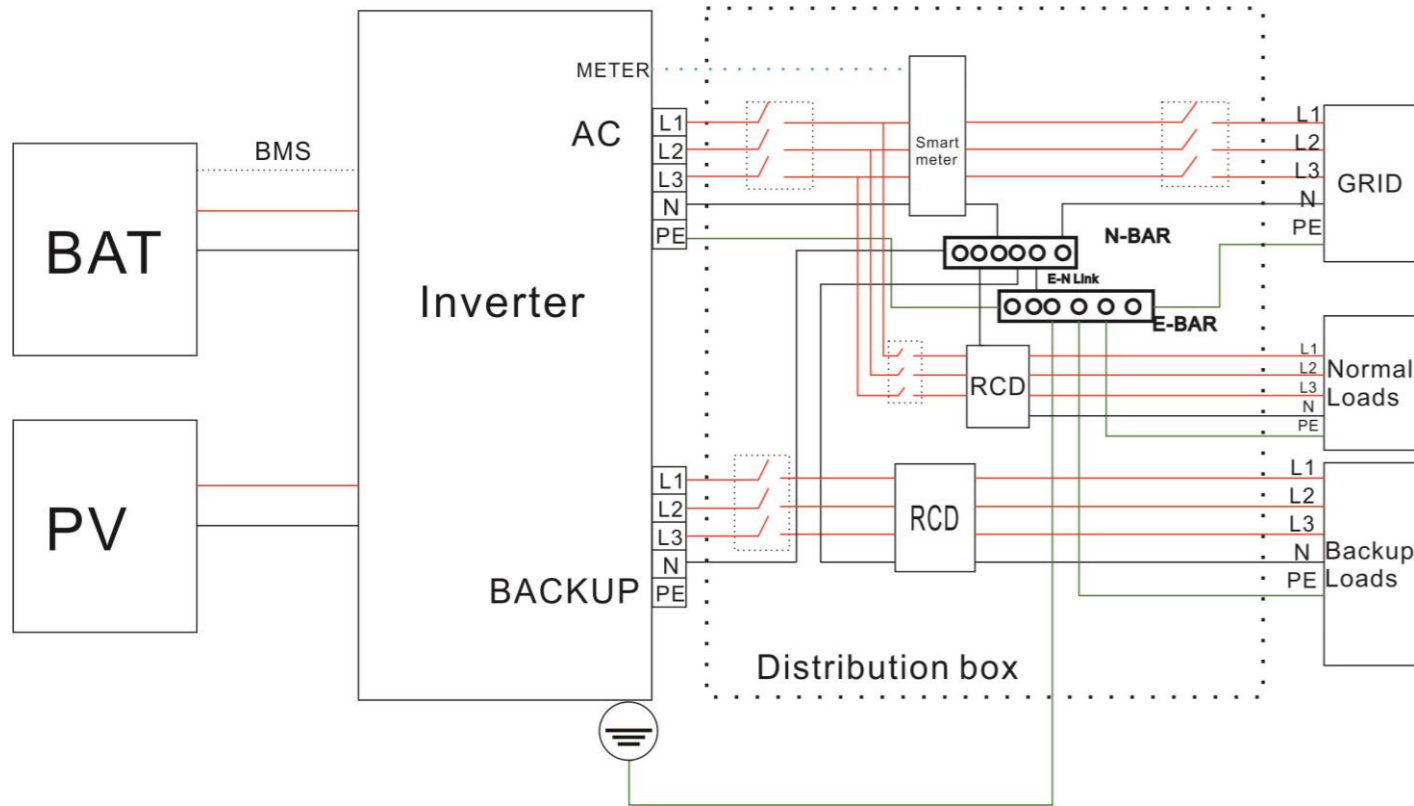

Figure 5.15 Connecting battery power cables

5.7 System Connection HS2 Series

The system connection in Australia and New Zealand is as below, the neutral cable of AC and backup side must be connected together for the safety reason.
Note: DO NOT connect the PE terminal of BACKUP side.



The system connection for grid system without special requirements is as below.

Note: The backup PE line and earthing bar must be grounded properly. Otherwise, backup function may be inactive during blackout.

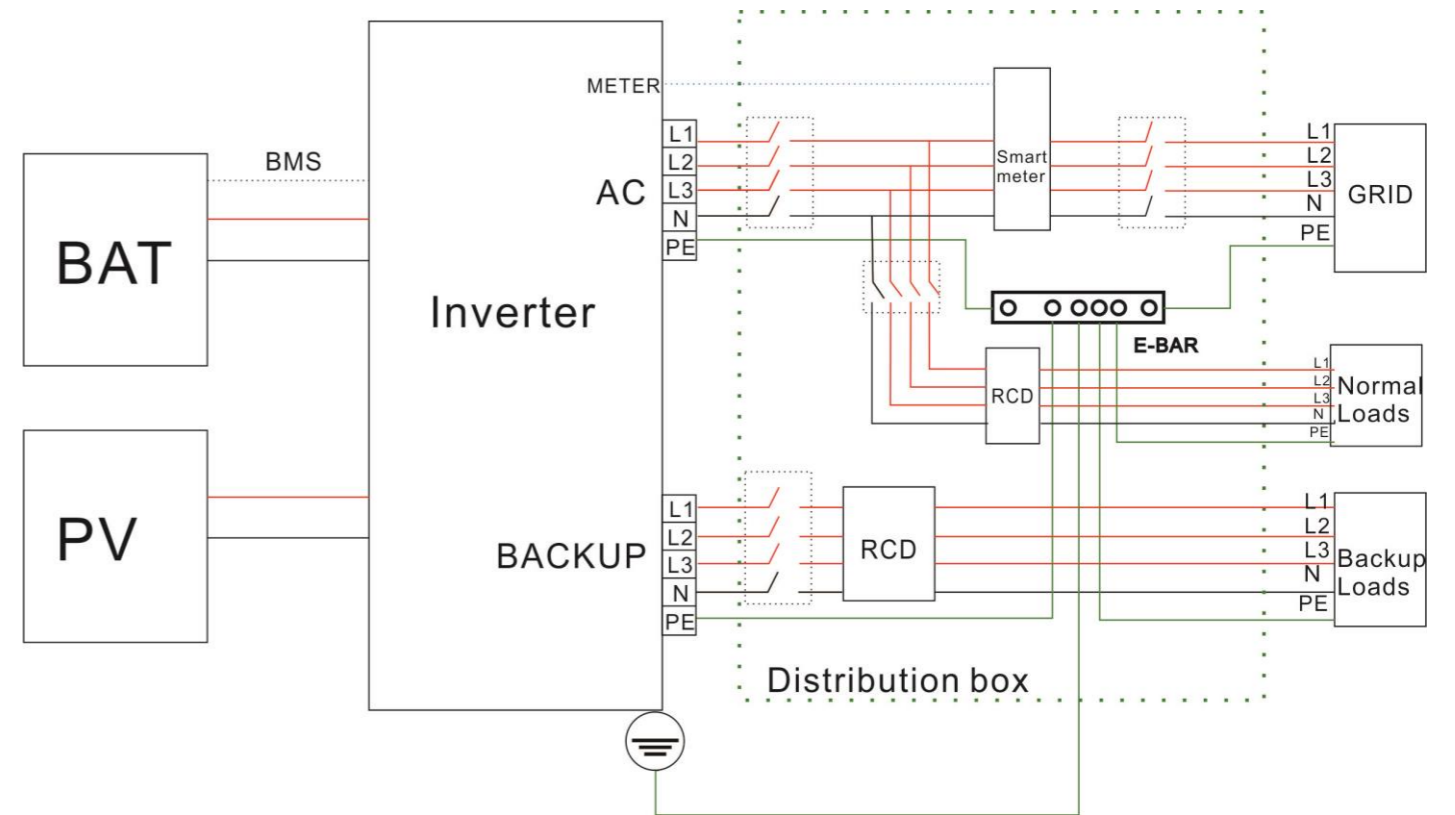

AS2 Series

The system connection in Germany, Australia and New Zealand is as below, the neutral cable of AC and backup side must be connected together for the safety reason.
 Note: DO NOT connect the PE terminal of BACKUP side.

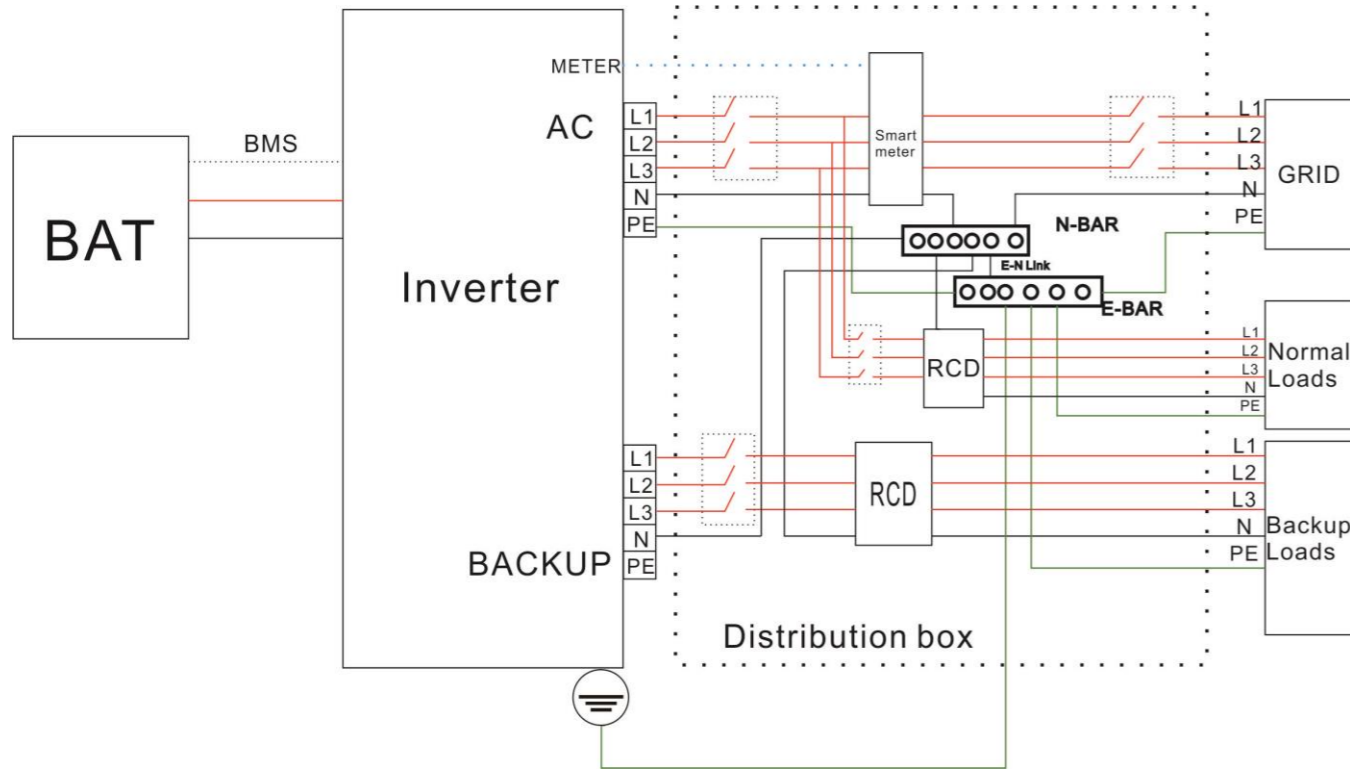

The system connection for grid system without special requirements is as below.

Note: The backup PE line and earthing bar must be grounded properly. Otherwise, backup function may be inactive during blackout.

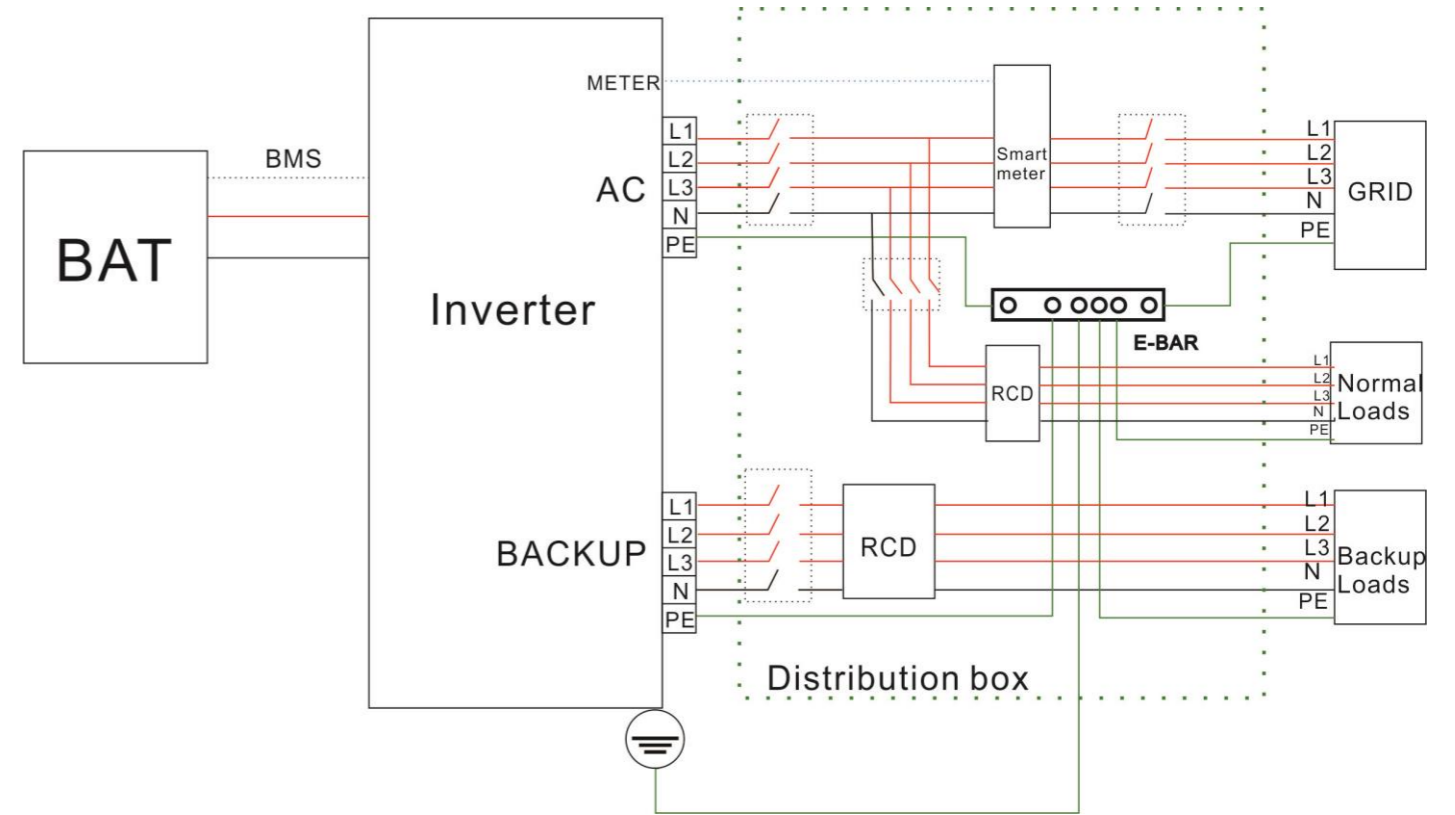

5.8 System Connection Diagram HS2

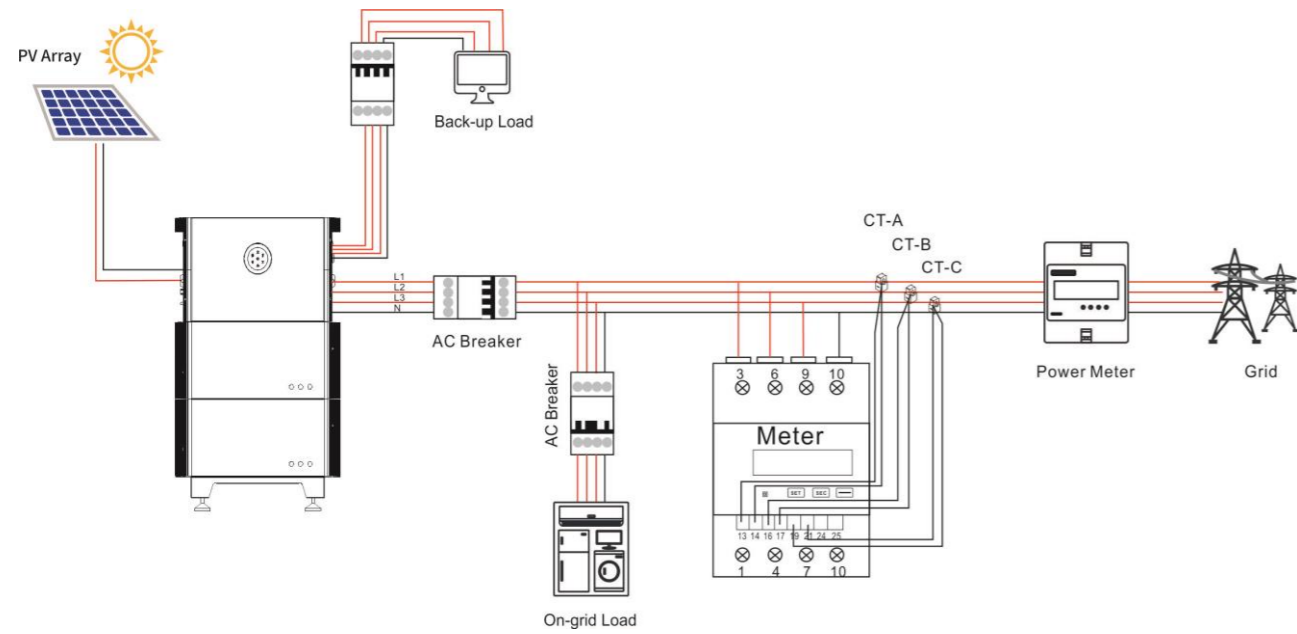

AS2

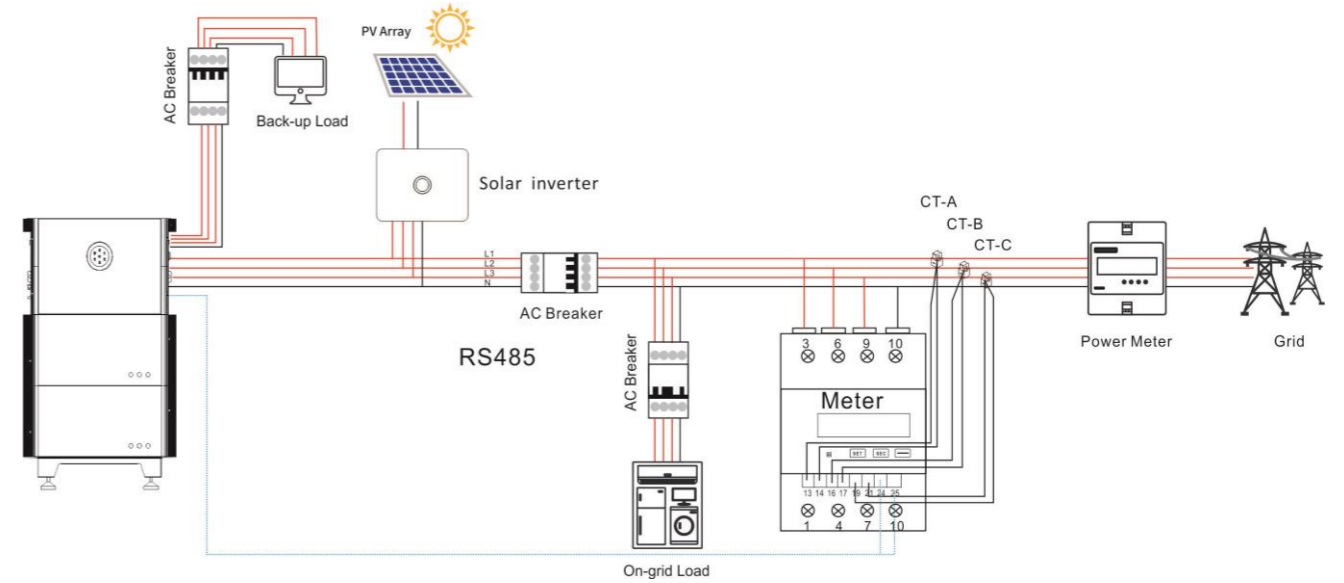

5.9 Installation of Side Covers of Battery Unit

Install the side covers for battery module and secure it with screws (M4*25).

Figure 5.16
Installing side covers for
battery module

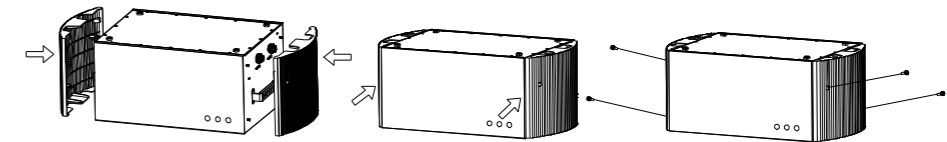

5.10 AFCI (Optional)

The inverter is equipped with arc-fault circuit interrupter (AFCI). With AFCI protection, when there is an arc signal on the DC side due to aging of the cable or loose contact, inverter can quickly detect and cut off the power to prevent fire, making the PV system run more safely.

6.

COMMISSIONING



6.1 Start Up and Shut Down the Energy Storage System

6.1.1 Start Up

Step 1: Turn on the circuit breaker

Step 2: Press and hold the main switch for 2-3s, until the display is on

6.1.2 Shut Down

Step 1: Press and hold the main switch for 5s, until the display is off

Step 2: Turn off the circuit breaker

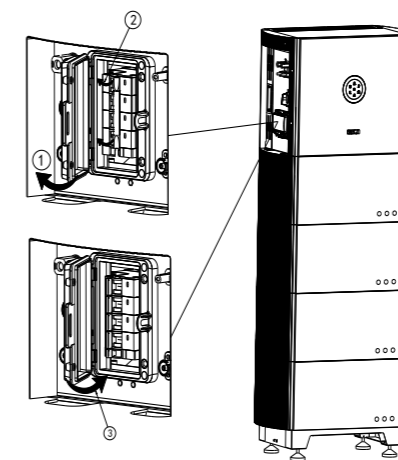

Figure 6.1
Circuit breaker of inverter

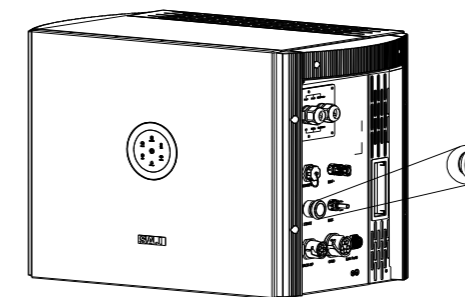

Figure 6.2
Start button of inverter

6.2 Introduction of Human-computer Interface

System commissioning

After the wiring is completed, please refer to the inverter manual for system commission and operation.

Note: Turn on the circuit breaker and main switch when using battery.

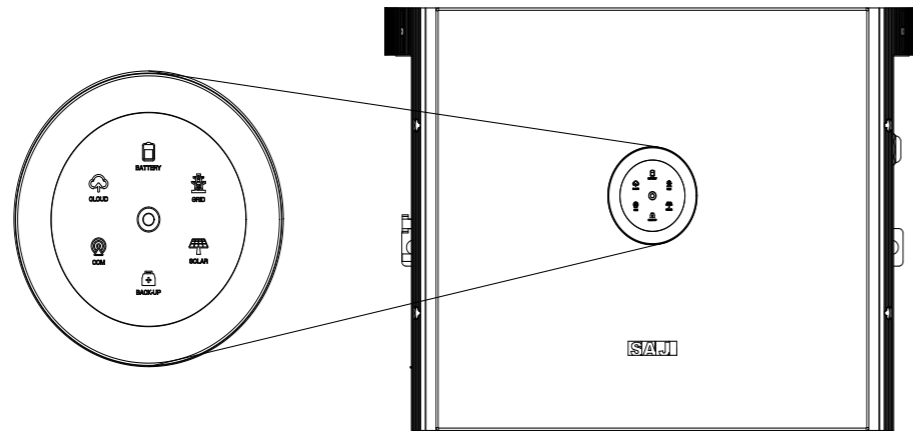

Figure 6.3
Human-computer interface

Table 6.1
Interface description

LED indicator	Status	Description
	LED off	Inverter power off
	Breathing	Inverter is at initial state or standby state
	Solid	Inverter running properly
	Breathing	Inverter is upgrading
	Solid	Inverter is faulty

 System	Solid	Importing electricity from grid
	On 1s, off 1s	Exporting electricity to grid
	On 1s, off 3s	Not importing and exporting at all
	Off	Off-grid
 Battery	Solid	Battery is discharging
	On 1s, off 1s	Battery is charging
	On 1s, off 3s	SOC low
	Off	Battery is disconnected or inactive
 Grid	Solid	Connected to grid
	On 1s, off 1s	Counting down to grid connection
	On 1s, off 3s	Grid is faulty
	Off	No grid
 PV	Solid	PV array is running properly
	On 1s, off 1s	PV array is faulty
	Off	PV array is not operating
 Backup	Solid	AC side load is running properly
	On 1s, off 1s	AC side load overload
	Off	AC side is turned off
 Communication	Solid	Both BMS and meter communication are good
	On 1s, off 1s	Meter communication is good, BMS communication is lost
	On 1s, off 3s	Meter communication is lost, BMS communication is good
	Off	Both meter and BMS communication are lost
 Cloud	Solid	Connected
	On 1s, off 1s	Connecting
	Off	Disconnected

Note: One breathing cycle is 6 seconds

6.3 Commissioning

Start up:

- (1) Connect the AC circuit breaker
- (2) Connect the DC circuit breaker between inverter and battery (if applicable)
- (3) Turn ON the battery (if applicable)
- (4) Turn ON the DC switch on the inverter
- (5) Install the communication module into the inverter
- (6) Setup the initial setting for inverter on eSAJ Home
- (7) Observe the LED indicators on the inverter to ensure the inverter is running properly

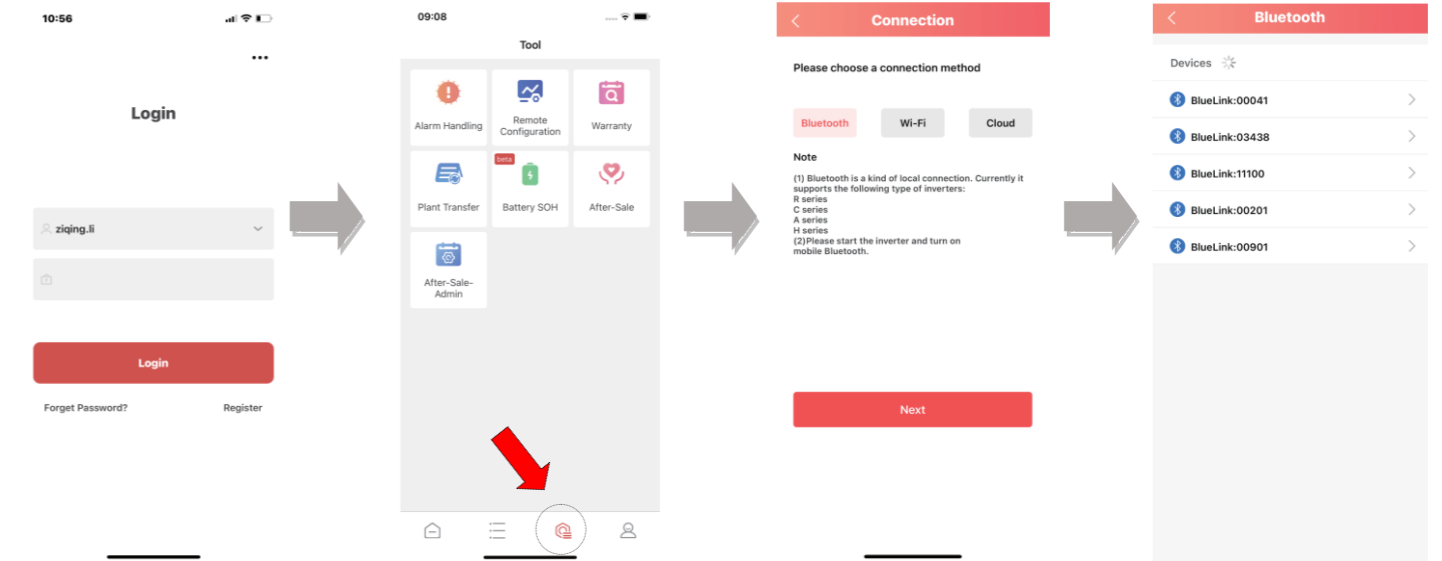

6.4 eSAJ APP Connection

6.4.1 Account Login

- Step 1: Log in to eSAJ Home, if you do not have an account, please register first.
- Step 2: Go to the "Tool" interface and select "Remote Configuration"
- Step 3: Click on "Bluetooth" and activate the Bluetooth function on your phone, then click on "Next"
- Step 4: Choose your inverter according to your inverter SN's tail numbers
- Step 5: Click on the inverter to enter inverter setting
- Step 6: Select the corresponding country and grid code

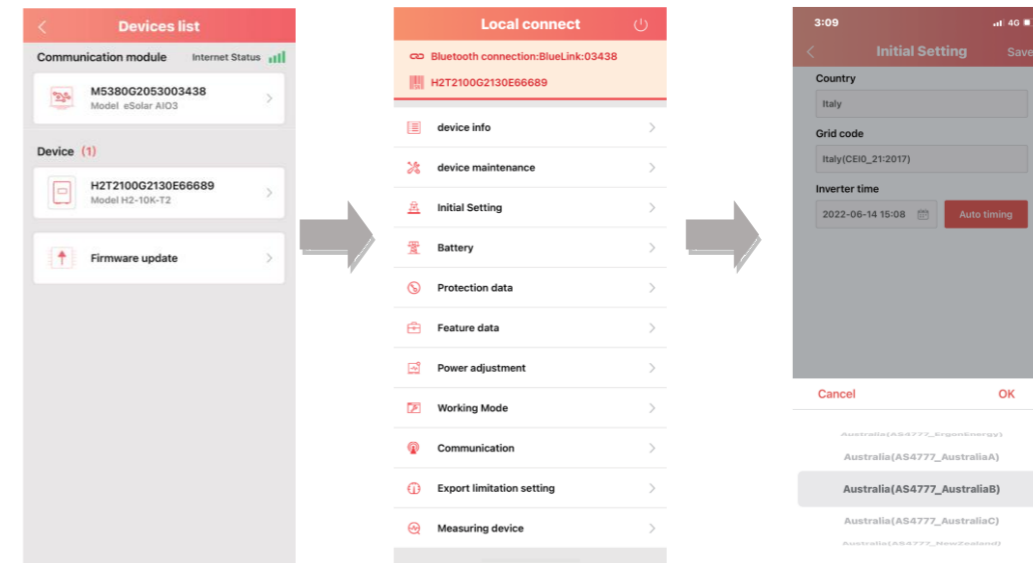

6.4.2 Local Connection

- Step 1: Open eSAJ APP and click on the dot icon on the top right corner
- Step 2: Select "Local Connection"
- Step 3: Enter password "123456"
- Step 4: Click on "Bluetooth" and activate the Bluetooth function on your phone, then click on "Next"
- Step 5: Choose your inverter according to your inverter SN's tail numbers
- Step 6: Click on the inverter to enter inverter setting
- Step 7: Select the corresponding country and grid code

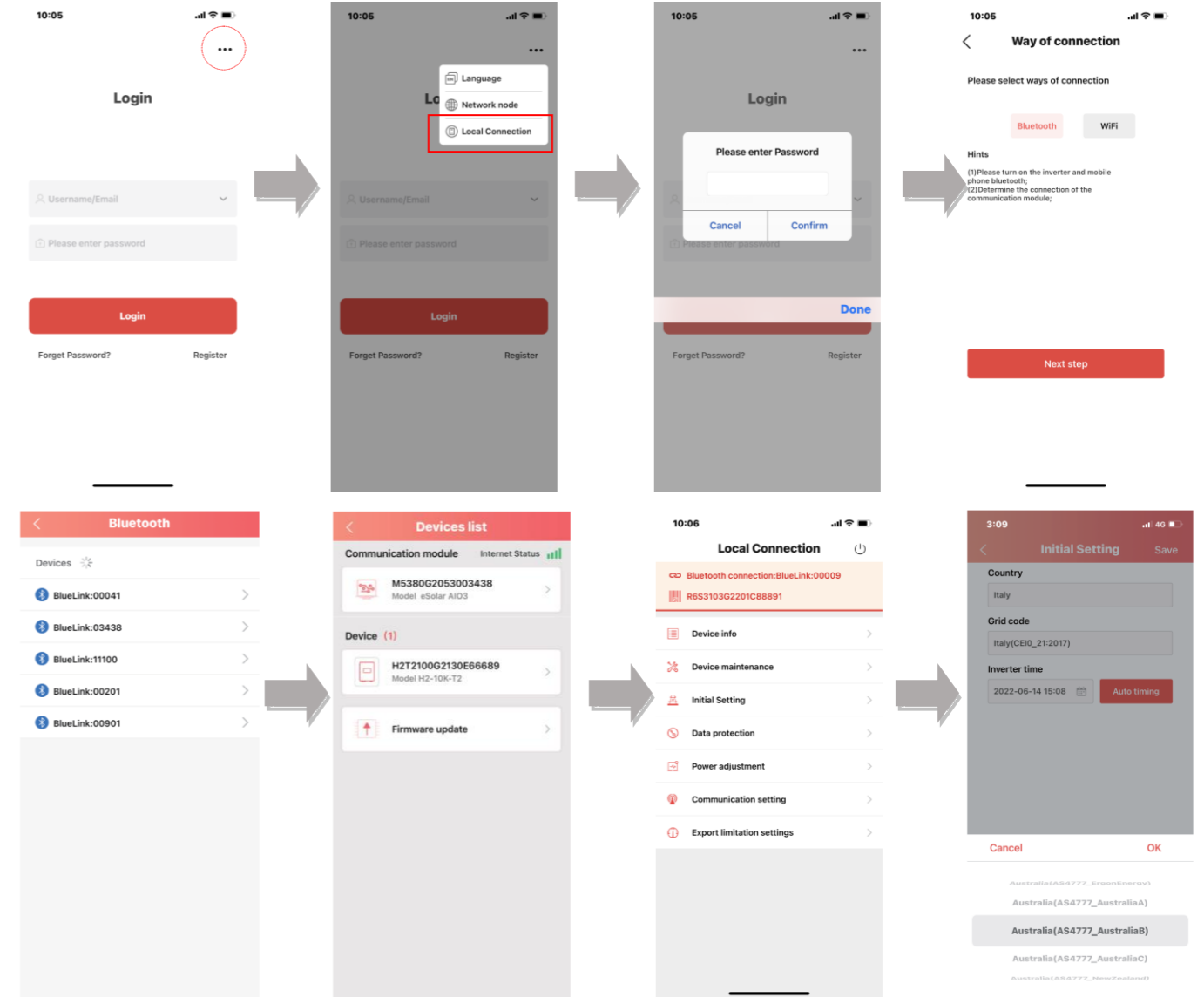

6.4.3 Inverter Setting Review

After commissioning, the device info including device basic info, running info and event info can be viewed. Country and grid code can be viewed from initial setting.

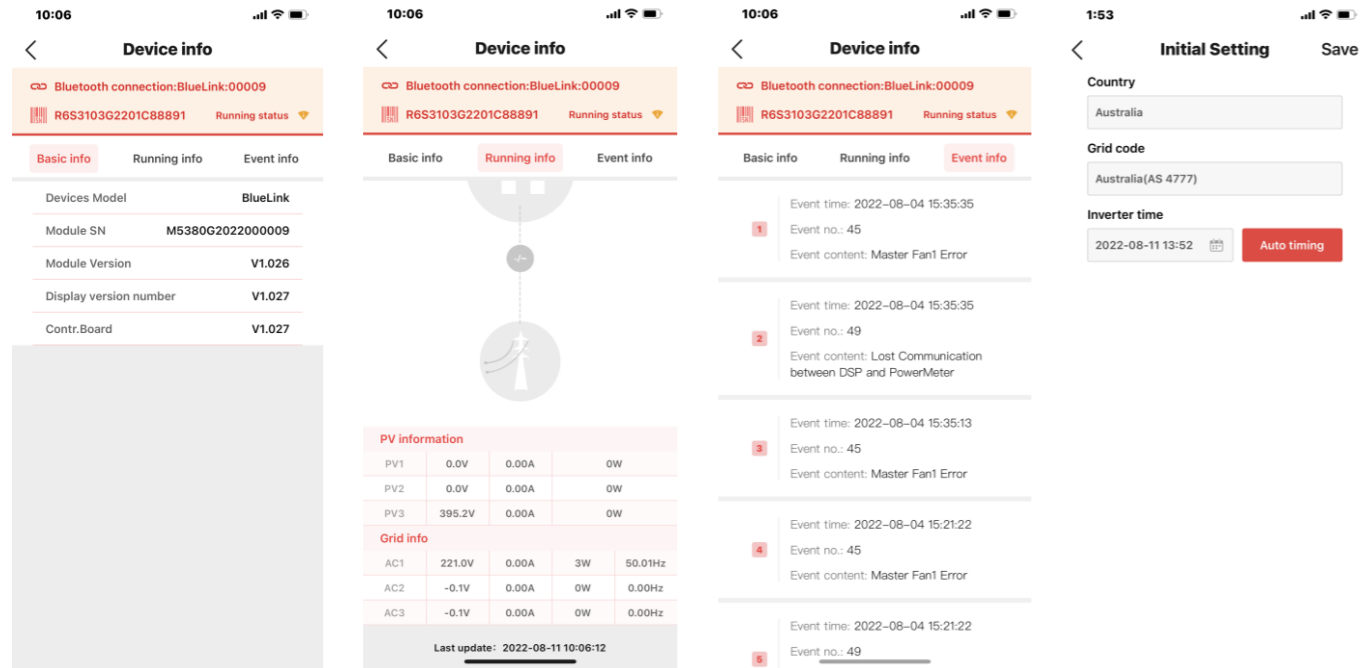

6.5 Working Modes

6.5.1 Selecting Working Modes Procedures

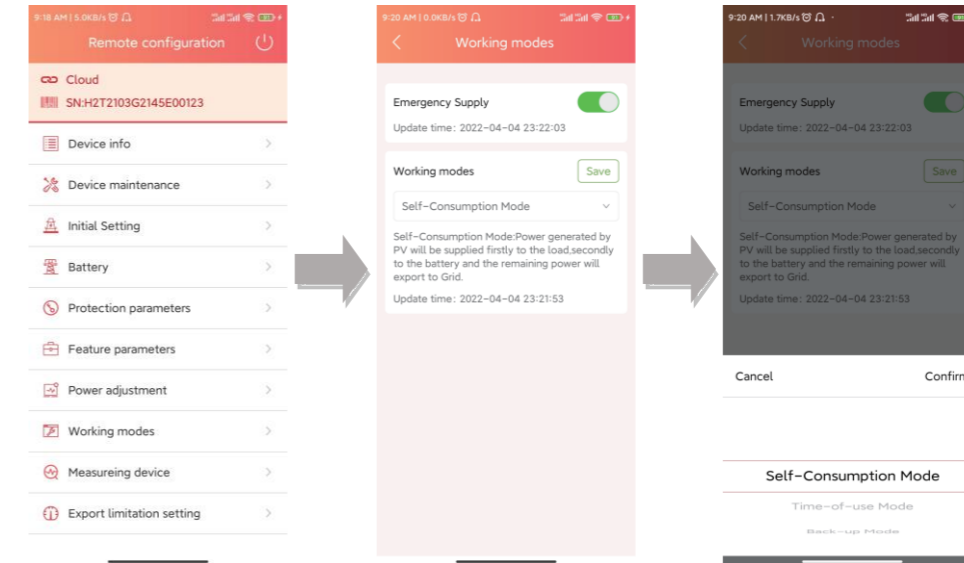

6.5.2 Working Modes Introduction

Self-consumption Mode: When the solar is sufficient, electricity generated by photovoltaic system will be supplied to load first, the surplus energy will be stored in battery, then the excess electricity will be exported to the grid. When the solar is insufficient, the battery will release electricity to supply load.

Back-up Mode: Reserved Backup SOC setting value can be adjusted, when battery SOC is less than reserved SOC value, battery can only be charged, until SOC reaches reserved value, the battery will be stopped charging; when SOC is larger than SOC setting value, battery will behave as Self-use mode.

Time-of-use Mode: Battery charging period and discharging period can be set , during charging period, battery can only be charged, while in discharging period, battery can only be discharged, the rest of the period, battery will behave as Self-use mode.

6.6 Export Limit Setting

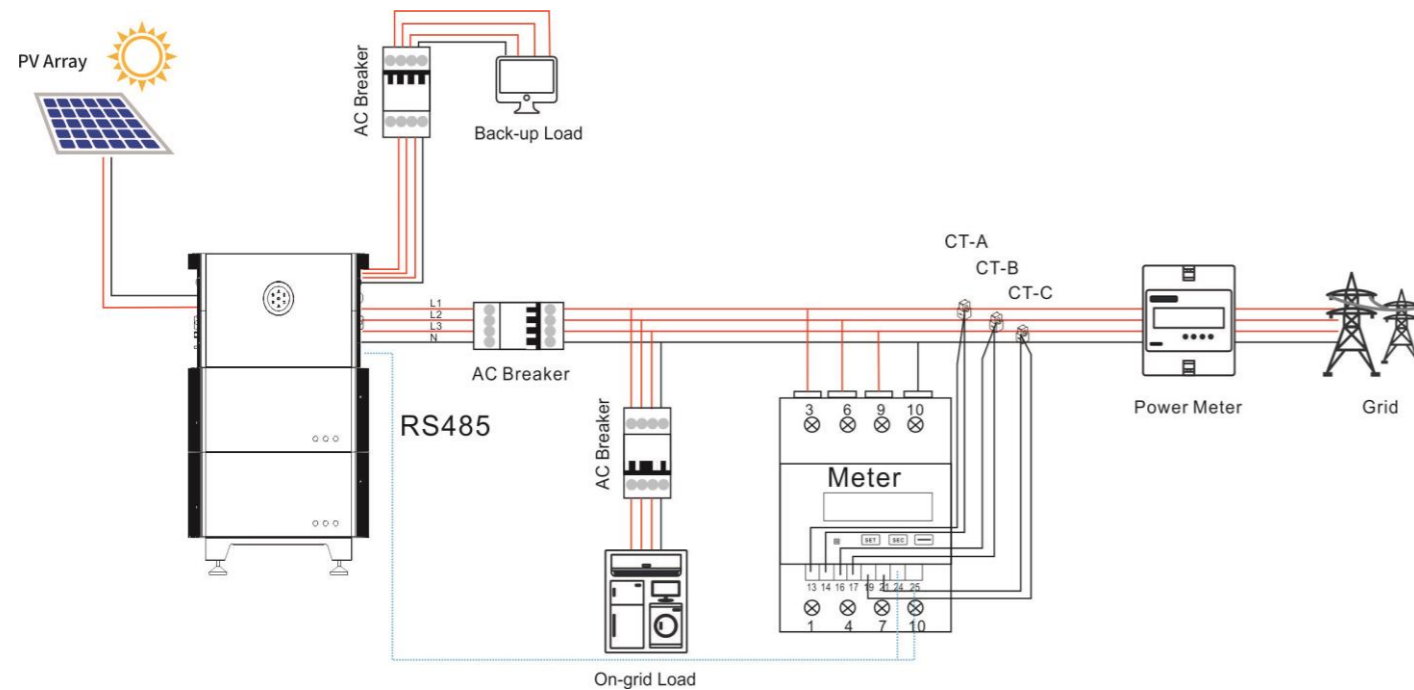

Note: If the RS485 cable length between inverter and meter is longer than 20m, please install the 120Ω resistor in port 24&25 of the meter.

6.6.1 APP setting

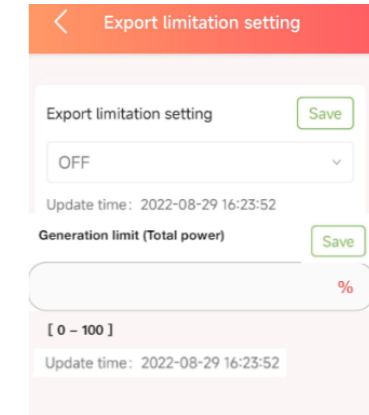
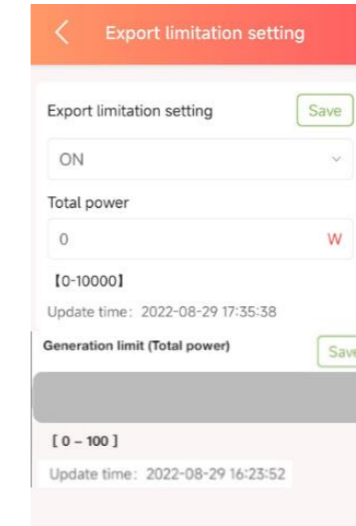
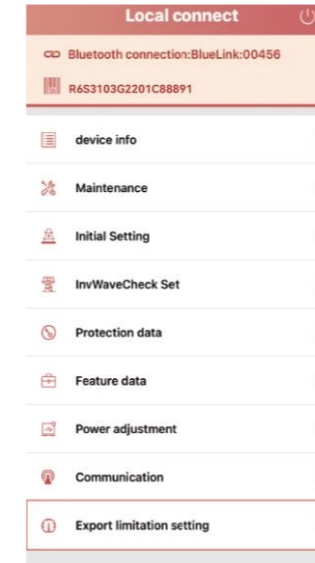

There are two methods to control the export limit, the two methods are alternative to each other.

Method 1: Export limitation setting is to control the export electricity to the grid.

Method 2: Generation limit is to control the electricity generated by the inverter.

6.7 Self-test (For Italy)









Italian Standard CEIO-21 requires a self-test function for all inverter that connected to utility grid. During the self-testing time, inverter will check the reaction time for over frequency, under frequency, overvoltage and undervoltage. This self-test is to ensure the inverter is able to disconnect from grid when required. If the self-test fails, the inverter will not able to feed into the grid.

The steps of running Self-test are as followed:

Step 1: Connect a communication module (Wi-Fi/ 4G/Ethernet) with inverter (connection procedure can refer to eSolar Module Quick Installation Manual)

Step 2: Select Italy for Country and choose your corresponding Grid Code from Initial Setting.

Step 3: You can choose self-test item required. Individual self-test time is approx. 5 minutes. All self-test time is approx. 40 minutes. After the self-test is completed, you can save the test report. If self-test is failed, please contact with SAJ or your inverter supplier.

	device maintenance	>
	Initial Setting	>
	InvWaveCheck Set	>
	Protection data	>
	Feature data	>
	Power adjustment	>
	Communication	>
	Export limitation setting	>
	Self-test	>

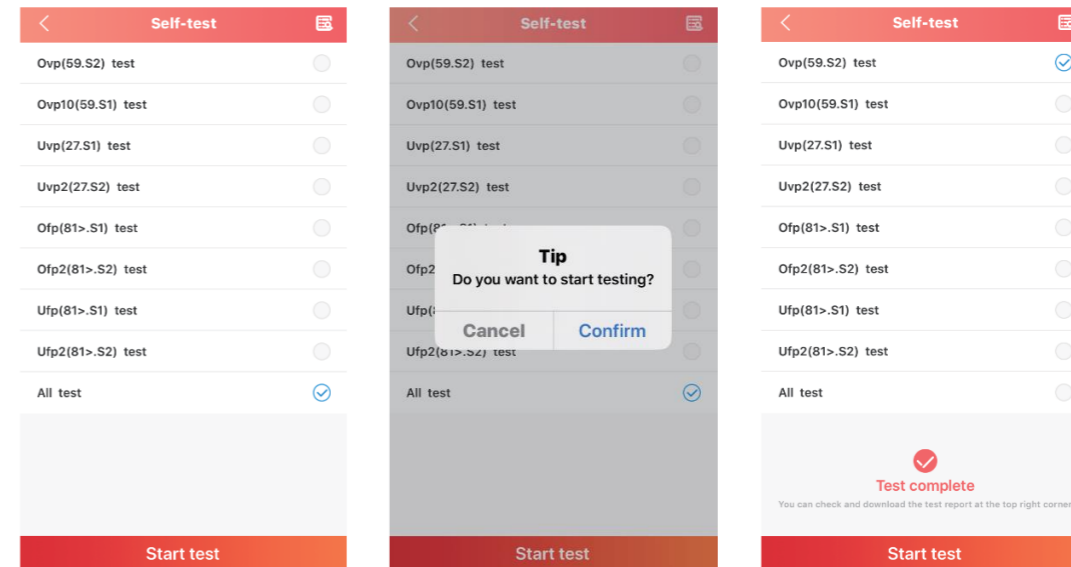

6.8 Setting Reactive Power Control (For Australia)

6.8.1 Setup Fixed Power Factor Mode & Fixed Reactive Power Mode

Fixed Power Factor Mode

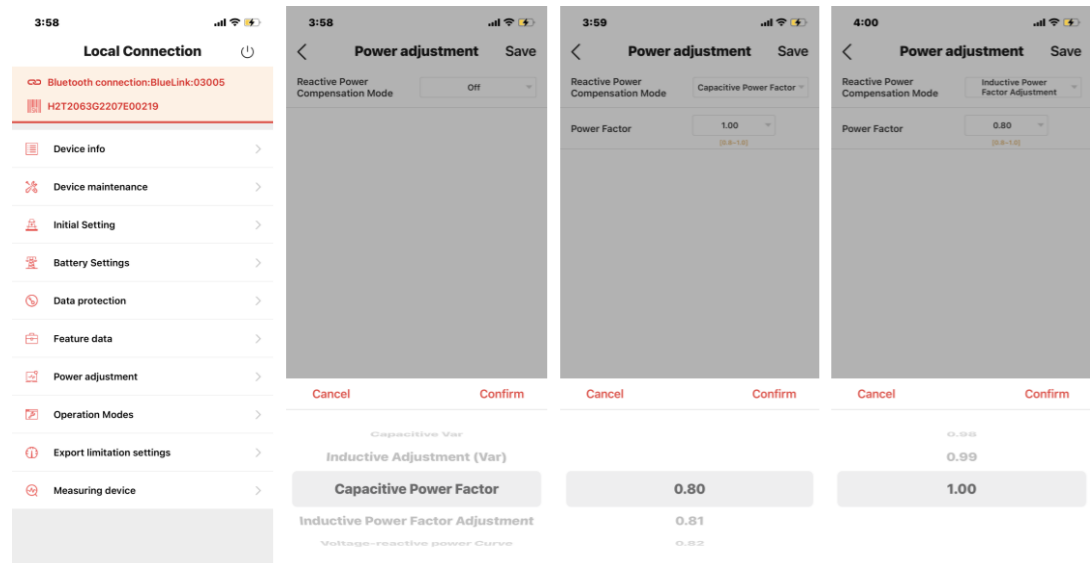

Step 1: Select Power Adjustment and enter password "201561".

Step 2: Select Capacitive Power Factor or Inductive Power Factor according to your local grid regulation. The power factor range is from 0.8 leading ~ 0.8 lagging.

Fixed Reactive Power Mode

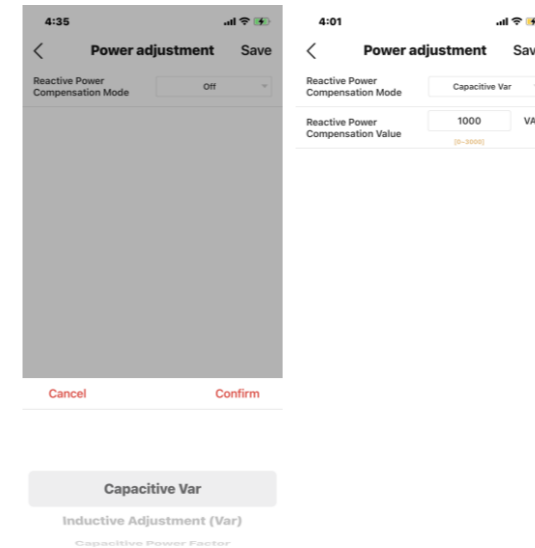

Step 1: Select Inductive Adjustment Var or Capacitive Var according to your local grid regulation. The power range is from -60%Pn ~ 60%Pn.

6.8.2 Setup V-Watt and Volt-Var Mode

This inverter complies with AS/NZS 4777.2: 2020 for power quality response modes. The inverter satisfies different regions of DNSPs' grid connection rules requirements for volt-watt and volt-var Settings. e.g.: AS4777 series setting as below.

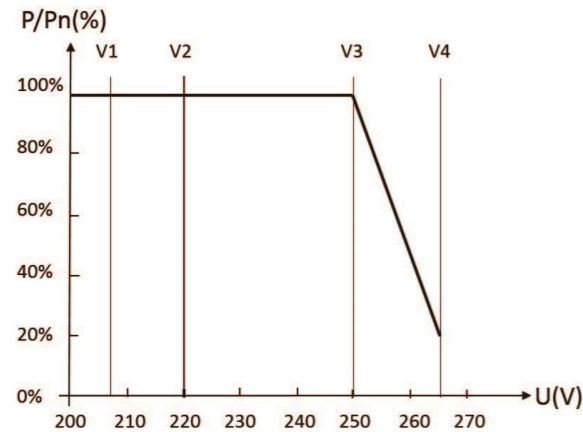

Figure 6.4

Curve for a Volt-Watt response mode (AS4777 Series)

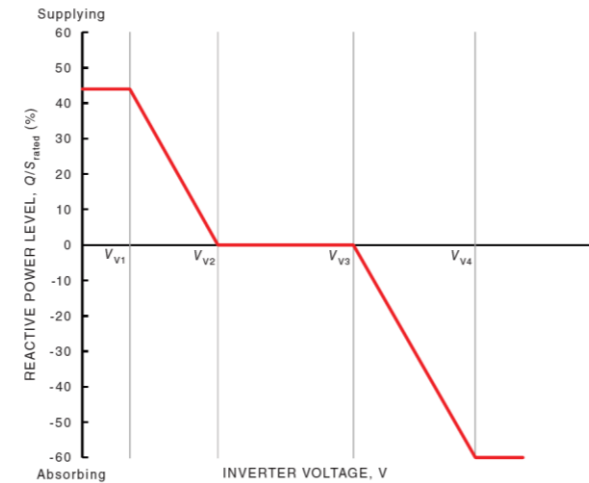
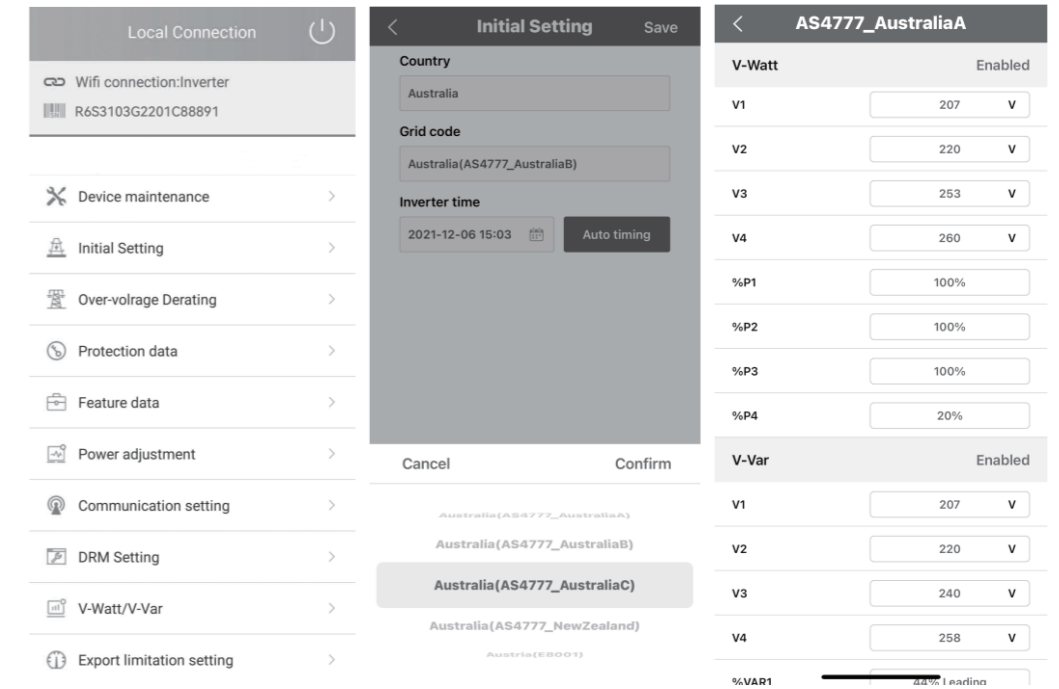

Figure 6.5

Curve for a Volt-Var control mode (AS4777 Series)

Setting procedure:

1. AS4777 grid compliance has been set during production, please select corresponding grid compliance according to state regulation during installation. You can choose a state regulation compliance with your local grid via eSAJ Home.
2. Log in to eSAJ Home, click "Local Connection", for connection procedure please refer to chapter 5.3 for Nearby monitoring.
3. Click "V-Watt/V-Var" to enter DNSPs settings, choose a suitable state regulation from the drop down list.



Note:

With regard to the Power rate limit mode, SAJ sets the product WGrA to 16.67%Pn by default in the following cases according to the requirements of 3.3.5.2 as 4777.2: 2020.

1. Soft ramp up after connect,
2. Reconnect or soft ramp up/down following a response to frequency disturbance.

7.

MAINTENANCE



7.1 Transportation

Lithium batteries are dangerous goods. Passed the test of UN38.3, this product meets the transportation requirements for dangerous goods for lithium batteries. After the installation of the battery on site, the original packaging (contains the lithium battery identification) should be kept. When the battery needs to be returned to the factory for repair, please pack the battery with the original packaging to reduce unnecessary trouble.

Take care of the product during transportation and storage, keep less than 4 cartons of inverter in one stack, keep less than 4 cartons of battery in one stack.

7.2 Storage

After purchasing the battery, please store it with following instructions:

- 1) Please store it in a dry and ventilated environment, keep it away from heat sources;
- 2) Please keep it in an environment with storage temperature as $-20^{\circ}\text{C} \sim 40^{\circ}\text{C}$, humidity $<85\% \text{ RH}$;
- 3) For long-term storage (>3 months), please put it in an environment with a temperature of -25°C to 25°C and a humidity of $< 85\% \text{ RH}$;
- 4) The battery should be stored in accordance with the storage requirements mentioned above, and the battery should be installed within 6 months since delivered from the factory and used with compatible inverters;

NOTICE

- The battery remains 50% power when it is sent from the factory.
- The longer the battery is stored, lower the SOC. When the battery remaining voltage fails to reach the startup voltage requirement, the battery may be damaged.
- Judgment condition: Close the battery breaker switch and press the main switch. At this time, if the LED light is solid green, it is running normal. If the LED light is red or off, the battery is in fault.

The battery cannot be disposed of as household refuse. When the service life of the battery reaches to the limit, it is not required to return it to the dealer or SAJ, but it must be recycled to the special waste lithium battery recycling station in the area.

Troubleshooting

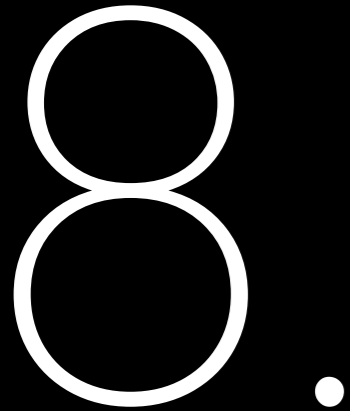

TROUBLESHOOTING & WARRANTY



Code	Fault Information
1	Master Relay Error
2	Master EEPROM Error
3	Master Temperature High Error
4	Master Temperature Low Error
5	Lost Communication M<->S
6	GFCI Device Error
7	DCI Device Error
8	Current Sensor Error
9	Master Phase1 Voltage High
10	Master Phase1 Voltage Low
11	Master Phase2 Voltage High
12	Master Phase2 Voltage Low
13	Master Phase3 Voltage High
14	Master Phase3 Voltage Low
15	Grid Voltage 10Min High
16	OffGrid Output Voltage Low
17	OffGrid Output Short Circuit
18	Master Grid Frequency High
19	Master Grid Frequency Low
20	BATInputMode Error
21	Phase1 DCV High
22	Phase2 DCV High
23	Phase3 DCV High
24	Master No Grid Error
25	DC ReverseConnect Error
26	Parallel machine CAN Com Error
27	GFCI Error
28	Phase1 DCI Error
29	Phase2 DCI Error
30	Phase3 DCI Error
31	ISO Error
32	Bus Voltage Balance Error
33	Master Bus Voltage High
34	Master Bus Voltage Low

Code	Fault Information
35	Master Grid Phase Lost
36	Master PV Voltage High
37	Master Islanding Error
38	Master HW Bus Voltage High
39	Master HW PV Current High
40	Master Self-Test Failed
41	Master HW Inv Current High
42	Master AC SPD Error
43	Master DC SPD Error
44	Master Grid NE Voltage Error
45	Master Fan1 Error
46	Master Fan2 Error
47	Master Fan3 Error
48	Master Fan4 Error
49	Lost Communication between Master and Meter
50	Lost Communication between M<->S
51	Lost Communication between inverter and Grid Meter
52	HMI EEPROM Error
53	HMI RTC Error
54	BMS Device Error
55	BMS Lost.Conn
56	CT Device Err
57	AFCI Lost Err
58	Lost Com. H<->S Err
59	Lost Communication between inverter and PV Meter
61	Slave Phase1 Voltage High
62	Slave Phase1 Voltage Low
63	Slave Phase2 Voltage High
64	Slave Phase2 Voltage Low
65	Slave Phase3 Voltage High
66	Slave Phase3 Voltage Low
67	Slave Frequency High

Code	Fault Information
68	Slave Frequency Low
73	Slave No Grid Error
74	Slave PV Input Mode Error
75	Slave HW PV Curr High
76	Slave PV Voltage High
77	Slave HW Bus Volt High
81	Lost Communication D<->C
83	Master Arc Device Error
84	Master PV Mode Error
85	Authority expires
86	DRM0 Error
87	Master Arc Error
88	Master SW PV Current High
89	Battery Voltage High
90	Battery Current High
91	Battery Charge Voltage High
92	Battery OverLoad
93	Battery SoftConnet TimeOut
94	Output OverLoad
95	Battery Open Circuit Error
96	Battery Discharge Voltage Low
97	BMS Internal Communication Error
98	Battery Module Sequence Error
99	Discharge Overcurrent Protection
100	Charge Overcurrent Protection
101	Module Under Voltage Protection
102	Module Over Voltage Protection
103	Single Cell Under Voltage Protection
104	Single Cell Over Voltage Protection

Code	Fault Information
105	BMS hardware error
106	Charging temperature low protection
107	Charging temperature high protection
108	Discharging temperature low protection
109	Discharging temperature high protection
110	BMS relay error
111	Pre-charge error
112	BMS Insulation error
113	BMS supplier incompatibility
114	Battery cell supplier impartibility
115	Battery cell incompatibility
116	Voltage inconsistency
117	Circuit breaker is open
118	Temperature difference is too wide
119	Voltage difference is too wide (Class II)
120	Voltage difference is too wide (Class I)
121	BMS over temperature protect
122	Short circuit protect
123	Total voltage match failed
124	The system is locked
125	FUSE error protection
126	Voltage on charging port is high protection

Warranty

Please go to SAJ website for warranty conditions and terms
<https://www.saj-electric.com/>

Please contact your supplier for troubleshooting and remedy.